

# XBee™/XBee-PRO™ OEM RF Modules

---

XBee/XBee-PRO OEM RF Modules  
RF Module Operation  
RF Module Configuration  
Appendices



## Product Manual v1.x8x - 802.15.4 Protocol

For OEM RF Module Part Numbers: XB24-...-001, XBP24-...-001

IEEE® 802.15.4 OEM RF Modules by MaxStream, Inc.



**MaxStream®**

355 South 520 West, Suite 180

Lindon, UT 84042

Phone: (801) 765-9885

Fax: (801) 765-9895

rf-xperts@maxstream.net  
www.MaxStream.net (live chat support)

M100232  
2006.07.12

**© 2006 MaxStream, Inc. All rights reserved**

The contents of this manual may not be transmitted or reproduced in any form or by any means without the written permission of MaxStream, Inc.

XBee™ and XBee-PRO™ are trademarks of MaxStream, Inc.

**Technical Support:**

Phone: (801) 765-9885

Live Chat: [www.maxstream.net](http://www.maxstream.net)

E-mail: [rf-xperts@maxstream.net](mailto:rf-xperts@maxstream.net)

# Contents

<b>1. XBee/XBee-PRO OEM RF Modules</b>	<b>4</b>	<b>Appendix A: Agency Certifications</b>	<b>47</b>
<b>1.1. Key Features</b>	<b>4</b>	<b>FCC Certification</b>	<b>47</b>
1.1.1. Worldwide Acceptance	4	OEM Labeling Requirements	47
<b>1.2. Specifications</b>	<b>5</b>	FCC Notices	47
<b>1.3. Mechanical Drawings</b>	<b>6</b>	FCC-approved Antennas	48
<b>1.4. Pin Signals</b>	<b>7</b>	<b>European Certification</b>	<b>49</b>
<b>1.5. Electrical Characteristics</b>	<b>7</b>	OEM Labeling Requirements	49
<b>2. RF Module Operation</b>	<b>8</b>	Restrictions	49
<b>2.1. Serial Communications</b>	<b>8</b>	Declarations of Conformity	49
2.1.1. UART Data Flow	8	Antenna Usage (Europe)	50
2.1.2. Flow Control	9	<b>IC (Industry Canada) Certification</b>	<b>50</b>
2.1.3. Transparent Operation	10	Labeling Requirements	50
2.1.4. API Operation	10	<b>Appendix B: Development Guide</b>	<b>51</b>
<b>2.2. IEEE 802.15.4 Networks</b>	<b>11</b>	<b>Development Kit Contents</b>	<b>51</b>
2.2.1. NonBeacon	11	Interfacing Options	51
2.2.2. NonBeacon (w/ Coordinator)	11	<b>RS-232 Development Board</b>	<b>52</b>
2.2.3. Association	12	External Interface	52
<b>2.3. Modes of Operation</b>	<b>15</b>	RS-232 Pin Signals	53
2.3.1. Idle Mode	15	Wiring Diagrams	54
2.3.2. Transmit & Receive Modes	15	Adapters	55
2.3.3. Sleep Mode	17	<b>USB Development Board</b>	<b>56</b>
2.3.4. Command Mode	19	External Interface	56
<b>2.4. Addressing</b>	<b>20</b>	USB Pin Signals	56
2.4.1. Unicast Mode	20	<b>X-CTU Software</b>	<b>57</b>
2.4.2. Broadcast Mode	20	Install	57
<b>3. RF Module Configuration</b>	<b>21</b>	Serial Communications Software	57
<b>3.1. Programming the RF Module</b>	<b>21</b>	<b>Appendix C: Additional Information</b>	<b>58</b>
3.1.1. Programming Examples	21	<b>1-Year Warranty</b>	<b>58</b>
<b>3.2. Command Reference Tables</b>	<b>22</b>	<b>Ordering Information</b>	<b>58</b>
<b>3.3. Command Descriptions</b>	<b>28</b>	<b>Contact MaxStream</b>	<b>59</b>
<b>3.4. API Operation</b>	<b>42</b>		
3.4.1. API Frame Specifications	42		
3.4.2. API Types	43		

# 1. XBee/XBee-PRO OEM RF Modules

XBee and XBee-PRO RF Modules were engineered to meet IEEE 802.15.4 standards and support the unique needs of low-cost, low-power wireless sensor networks. The modules require minimal power and provide reliable delivery of data between devices.

The modules operate within the ISM 2.4 GHz frequency band and are pin-for-pin compatible with each other.



## 1.1. Key Features

### High Performance, Low Cost

XBee

- Indoor/Urban: up to 100' (30 m)
- Outdoor line-of-sight: up to 300' (100 m)
- Transmit Power: 1 mW (0 dBm)
- Receiver Sensitivity: -92 dBm

XBee-PRO

- Indoor/Urban: up to 300' (100 m)
- Outdoor line-of-sight: up to 1 mile (1500 m)
- Transmit Power: 100 mW (20 dBm) EIRP
- Receiver Sensitivity: -100 dBm

RF Data Rate: 250,000 bps

### Advanced Networking & Security

- Retries and Acknowledgements
- DSSS (Direct Sequence Spread Spectrum)
- Each direct sequence channels has over 65,000 unique network addresses available
- Point-to-point, point-to-multipoint and peer-to-peer topologies supported
- Coordinator/End Device operations supported
- 128-bit Encryption (downloadable firmware version coming soon)
- Transparent and API operation

### Low Power

XBee

- TX Current: 45 mA (@3.3 V)
- RX Current: 50 mA (@3.3 V)
- Power-down Current: < 10 µA

XBee-PRO

- TX Current: 215 mA (@3.3 V)
- RX Current: 55 mA (@3.3 V)
- Power-down Current: < 10 µA

### Easy-to-use

No configuration necessary for out-of box RF communications

Free X-CTU Software (Testing and configuration software)

Small form factor

Network compatible with other 802.15.4 devices

AT and API Command Modes for configuring module parameters

**Free & Unlimited Technical Support**

### 1.1.1. Worldwide Acceptance

**FCC Approval** (USA) Refer to Appendix A [p47] for FCC Requirements. Systems that contain XBee/XBee-PRO RF Modules inherit MaxStream Certifications.

**ISM** (Industrial, Scientific & Medical) 2.4 GHz frequency band

Manufactured under **ISO 9001:2000** registered standards

XBee/XBee-PRO RF Modules are optimized for use in **US, Canada, Australia, Israel and Europe** (contact MaxStream for complete list of agency approvals).



## 1.2. Specifications

Table 1-01. Specifications of the XBee/XBee-PRO OEM RF Modules

Specification	XBee	XBee-PRO
<b>Performance</b>		
Range: Indoor/Urban (w/ 1.9 dB Whip or 2.1 dB Dipole antenna)	up to 100 ft. (30m)	up to 300' (100m)
Range: Outdoor RF line-of-sight (w/ 1.9 dB Whip or 2.1 dB Dipole antenna)	up to 300 ft. (100m)	up to 1 mile (1500m)
Transmit Power Output (software selectable)	1mW (0 dBm)	60 mW (18 dBm) conducted, 100 mW (20 dBm) EIRP*
RF Data Rate	250,000 bps	250,000 bps
Interface Data Rate (software selectable)	1200 - 115200 bps (non-standard baud rates also supported)	1200 - 115200 bps (non-standard baud rates also supported)
Receiver Sensitivity	-92 dBm (1% packet error rate)	-100 dBm (1% packet error rate)
<b>Power Requirements</b>		
Supply Voltage	2.8 – 3.4 V	2.8 – 3.4 V
Transmit Current (typical)	45mA (@ 3.3 V)	If PL=0 (10dBm): 137mA(@3.3V), 139mA(@3.0V) PL=1 (12dBm): 155mA (@3.3V), 153mA(@3.0V) PL=2 (14dBm): 170mA (@3.3V), 171mA(@3.0V) PL=3 (16dBm): 188mA (@3.3V), 195mA(@3.0V) PL=4 (18dBm): 215mA (@3.3V), 227mA(@3.0V)
Idle / Receive Current (typical)	50mA (@ 3.3 V)	55mA (@ 3.3 V)
Power-down Current (@ 3.0 V)	< 10 µA	< 10 µA
<b>General</b>		
Operating Frequency	ISM 2.4 GHz	ISM 2.4 GHz
Dimensions	0.960" x 1.087" (2.438cm x 2.761cm)	0.960" x 1.297" (2.438cm x 3.294cm)
Operating Temperature	-40 to 85° C (Industrial)	-40 to 85° C (Industrial)
Antenna Options	Integrated Whip, Chip or U.FL Connector	Integrated Whip, Chip or U.FL Connector
<b>Networking &amp; Security</b>		
Supported Network Topologies	Point-to-Point, Point-to-Multipoint, Peer-to-Peer	Point-to-Point, Point-to-Multipoint, Peer-to-Peer
Number of Channels (software selectable)	16 Direct Sequence Channels	12 Direct Sequence Channels
Addressing Options	PAN ID, Channel and Source/Destination Addresses	PAN ID, Channel and Source/Destination Addresses
<b>Agency Approvals</b>		
United States (FCC Part 15.247)	OUR-XBEE	OUR-XBEEPRO
Industry Canada (IC)	4214A-XBEE	4214A-XBEEPRO
Europe (CE)	ETSI	ETSI (Max. 10 dBm transmit power output)*

\* When operating in Europe: XBee-PRO RF Modules must be configured to operate at a maximum transmit power output level of 10 dBm. The power output level is set using the PL command. The PL parameter must equal "0" (10 dBm).

Additionally, European regulations stipulate an EIRP power maximum of 12.86 dBm (19 mW) for the XBee-PRO and 12.11 dBm for the XBee when integrating high-gain antennas.

Regarding Antenna Options: The ranges specified are typical when using the integrated Whip (1.5 dBi) and Dipole (2.1 dBi) antennas. The Chip antenna option provides advantages in its form factor; however, it typically yields shorter range than the Whip and Dipole antenna options (especially outdoors). For more information, refer to the "XBee Antenna" application note located on MaxStream's web site (<http://www.maxstream.net/support/knowledgebase/article.php?kb=153>).

## 1.3. Mechanical Drawings

**Figure 1-01. Mechanical drawings of the XBee/XBee-PRO OEM RF Modules (antenna options not shown)**

The XBee and XBee-PRO RF Modules are pin-for-pin compatible.

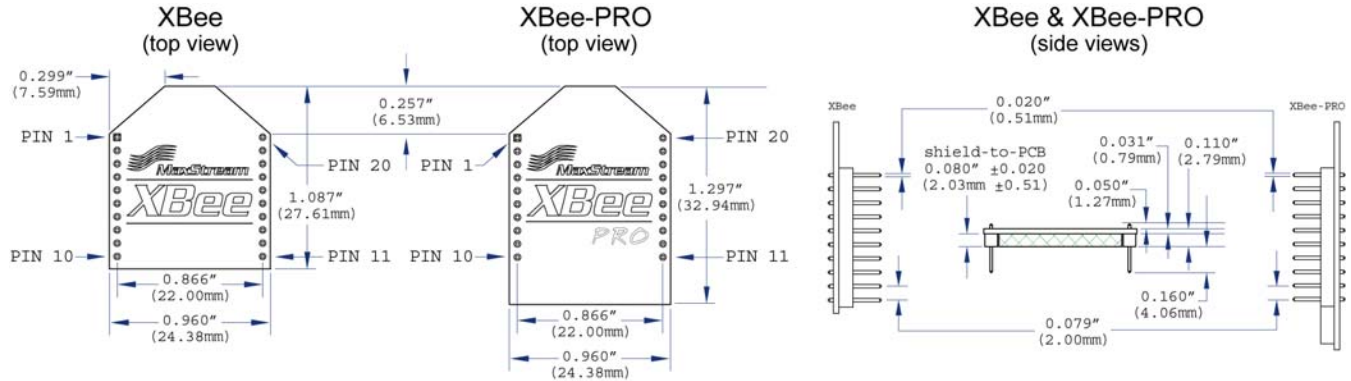

XBee/XBee-PRO RF Modules were engineered to mount into a socket and therefore do not require any soldering when mounting them to a board. The XBee Development Kits contain RS-232 and USB interface boards which use two one-row headers to receive modules.

**Figure 1-02. XBee Module Mounting to an RS-232 Interface Board.**

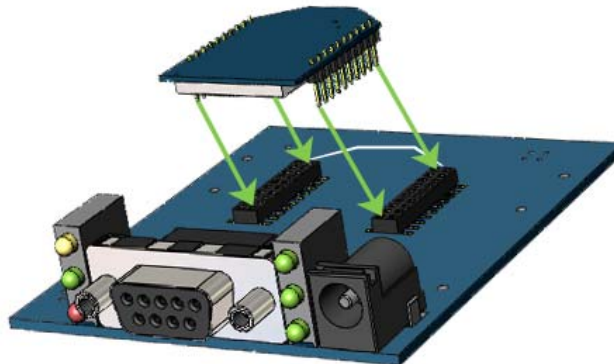

The sockets used on the MaxStream interface boards are manufactured by Samtec; however, several other manufacturers provide excellent alternatives. As a point-of-reference, MaxStream currently uses the following socket (header) solutions:

- Through-hole single-row headers -  
Samtec P/N: MMS-110-01-L-SV (or equivalent)
- Surface-mount double-row headers -  
Century Interconnect P/N: CPRMSL20-D-0-1 (or equivalent)
- Surface-mount single-row headers -  
Samtec P/N: SMM-110-02-SM-S

MaxStream also recommends printing an outline of the module on the board to indicate the orientation the module should be mounted.

## 1.4. Pin Signals

**Figure 1-03. XBee/XBee-PRO RF Module Pin Number**  
(top sides shown - shields on bottom)

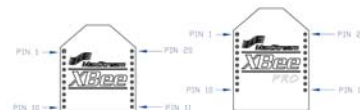

**Table 1-02. Pin Assignments for the XBee and XBee-PRO Modules**  
(Low-asserted signals are distinguished with a horizontal line above signal name.)

Pin #	Name	Direction	Description
1	VCC	-	Power supply
2	DOUT	Output	UART Data Out
3	DIN / <u>CONFIG</u>	Input	UART Data In
4	<u>DO8</u> *	Output	Digital Output 8
5	<u>RESET</u>	Input	Module Reset
6	PWM0 / RSSI	Output	PWM Output 0 or RX Signal Strength Indicator
7	[reserved]	-	Do not connect
8	[reserved]	-	Do not connect
9	<u>DTR</u> / <u>SLEEP_RQ</u> / DI8	Input	Pin Sleep Control Line or Digital Input 8
10	GND	-	Ground
11	<u>AD4</u> * / <u>DIO4</u> *	Either	Analog Input 4 or Digital I/O 4
12	<u>CTS</u> / <u>DIO7</u> *	Either	Clear-to-Send Flow Control or Digital I/O 7
13	<u>ON</u> / <u>SLEEP</u>	Output	Module Status Indicator
14	VREF*	Input	Voltage Reference for A/D Inputs
15	<u>Associate</u> / <u>AD5</u> * / <u>DIO5</u> *	Either	Associated Indicator, Analog Input 5 or Digital I/O 5
16	<u>RTS</u> / <u>DIO6</u> *	Either	Request-to-Send Flow Control or Digital I/O 6
17	<u>AD3</u> * / <u>DIO3</u> *	Either	Analog Input 3 or Digital I/O 3
18	<u>AD2</u> * / <u>DIO2</u> *	Either	Analog Input 2 or Digital I/O 2
19	<u>AD1</u> * / <u>DIO1</u> *	Either	Analog Input 1 or Digital I/O 1
20	<u>AD0</u> * / <u>DIO0</u> *	Either	Analog Input 0 or Digital I/O 0

\* Functions not supported at the time of this release.

### Design Notes:

- Minimum connections are: VCC, GND, DOUT and DIN.
- Signal Direction is specified with respect to the module
- Module includes a 50k  $\Omega$  pull-up resistor attached to RESET
- Several input pull-ups can be configured using the PE command
- Unused pins should be left disconnected

## 1.5. Electrical Characteristics

**Table 1-03. DC Characteristics of the XBee & XBee-PRO (VCC = 2.8 - 3.4 VDC)**

Symbol	Parameter	Condition	Min	Typical	Max	Units
V <sub>IL</sub>	Input Low Voltage	All Digital Inputs	-	-	0.35 * VCC	V
V <sub>IH</sub>	Input High Voltage	All Digital Inputs	0.7 * VCC	-	-	V
V <sub>OL</sub>	Output Low Voltage	I <sub>OL</sub> = 2 mA, VCC >= 2.7 V	-	-	0.5	V
V <sub>OH</sub>	Output High Voltage	I <sub>OH</sub> = -2 mA, VCC >= 2.7 V	VCC - 0.5	-	-	V
I <sub>IN</sub>	Input Leakage Current	V <sub>IN</sub> = VCC or GND, all inputs, per pin	-	0.025	1	$\mu$ A
I <sub>OZ</sub>	High Impedance Leakage Current	V <sub>IN</sub> = VCC or GND, all I/O High-Z, per pin	-	0.025	1	$\mu$ A
TX	Transmit Current	VCC = 3.3 V	-	45 (XBee) / 215 (PRO)	-	mA
RX	Receive Current	VCC = 3.3 V	-	50 (XBee) / 55 (PRO)	-	mA
PWR-DWN	Power-down Current	SM parameter = 1	-	< 10	-	$\mu$ A

## 2. RF Module Operation

### 2.1. Serial Communications

The XBee/XBee-PRO OEM RF Modules interface to a host device through a logic-level asynchronous serial port. Through its serial port, the module can communicate with any logic and voltage compatible UART; or through a level translator to any serial device (For example: MaxStream's proprietary RS-232 or USB interface board).

#### 2.1.1. UART Data Flow

Devices that have a UART interface can connect directly to the pins of the RF module as shown in the figure below.

**Figure 2-01. System Data Flow Diagram in a UART-interfaced environment**  
(Low-asserted signals distinguished with horizontal line over signal name.)

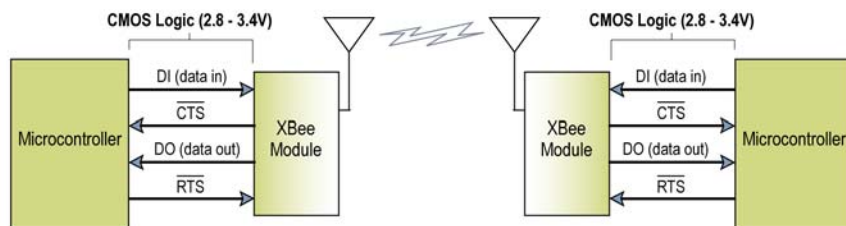

#### Serial Data

Data enters the module UART through the DI pin (pin 3) as an asynchronous serial signal. The signal should idle high when no data is being transmitted.

Each data byte consists of a start bit (low), 8 data bits (least significant bit first) and a stop bit (high). The following figure illustrates the serial bit pattern of data passing through the module.

**Figure 2-02. UART data packet 0x1F (decimal number "31") as transmitted through the RF module**  
Example Data Format is 8-N-1 (bits - parity - # of stop bits)

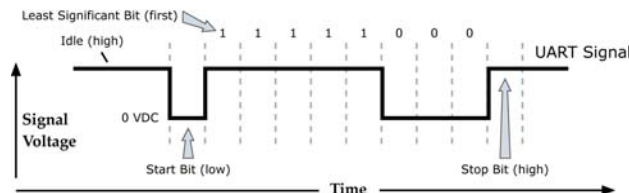

The module UART performs tasks, such as timing and parity checking, that are needed for data communications. Serial communications depend on the two UARTs to be configured with compatible settings (baud rate, parity, start bits, stop bits, data bits).

Both the module and host (PC) settings can be viewed and adjusted using MaxStream's proprietary X-CTU Software. Use the "PC Settings" tab to configure host settings. Use the "Terminal" or "Modem Configuration" tab to configure module settings.

**NOTE:** Failure to enter AT Command Mode is most commonly due to baud rate mismatch. Ensure the 'Baud' setting on the "PC Settings" tab matches the interface data rate of the RF module. By default, the BD parameter = 3 (9600 bps).

## 2.1.2. Flow Control

Figure 2-03. Internal Data Flow Diagram

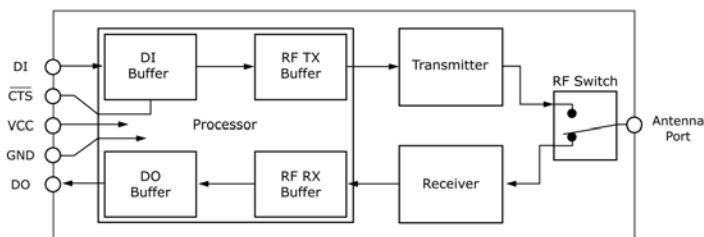

### DI (Data In) Buffer

When serial data enters the RF module through the DI pin (pin 3), the data is stored in the DI Buffer until it can be processed.

**Hardware Flow Control ( $\overline{\text{CTS}}$ ).** When the DI buffer is 17 bytes away from being full; by default, the module de-asserts  $\overline{\text{CTS}}$  (high) to signal to the host device to stop sending data [refer to D7 (DIO7 Configuration) parameter].  $\overline{\text{CTS}}$  is re-asserted after the DI Buffer has 34 bytes of memory available.

#### How to eliminate the need for flow control:

1. Send messages that are smaller than the DI buffer size.
2. Interface at a lower baud rate [BD (Interface Data Rate) parameter] than the throughput data rate.

#### Case in which the DI Buffer may become full and possibly overflow:

If the module is receiving a continuous stream of RF data, any serial data that arrives on the DI pin is placed in the DI Buffer. The data in the DI buffer will be transmitted over-the-air when the module is no longer receiving RF data in the network.

Refer to the RO (Packetization Timeout) [p38], BD (Baud Rate) [p30] and D7 (DIO7 Configuration) [p33] command descriptions for more information.

### DO (Data Out) Buffer

When RF data is received, the data enters the DO buffer and is sent out the serial port to a host device. Once the DO Buffer reaches capacity, any additional incoming RF data is lost.

**Hardware Flow Control ( $\overline{\text{RTS}}$ ).** If  $\overline{\text{RTS}}$  is enabled for flow control (D6 (DIO6 Configuration) Parameter = 1), data will not be sent out the DO Buffer as long as  $\overline{\text{RTS}}$  (pin 16) is de-asserted.

#### Two cases in which the DO Buffer may become full and possibly overflow:

1. If the RF data rate is set higher than the interface data rate of the module, the module will receive data from the transmitting module faster than it can send the data to the host.
2. If the host does not allow the module to transmit data out from the DO buffer because of being held off by hardware or software flow control.

Refer to the D6 (DIO6 Configuration) [p32] command description for more information.

### 2.1.3. Transparent Operation

By default, XBee/XBee-PRO RF Modules operate in Transparent Mode. When operating in this mode, the modules act as a serial line replacement - all UART data received through the DI pin is queued up for RF transmission. When RF data is received, the data is sent out the DO pin.

#### Serial-to-RF Packetization

Data is buffered in the DI buffer until one of the following causes the data to be packetized and transmitted:

1. No serial characters are received for the amount of time determined by the RO (Packetization Timeout) parameter. If RO = 0, packetization begins when a character is received.
2. The maximum number of characters that will fit in an RF packet (100) is received.
3. The Command Mode Sequence (GT + CC + GT) is received. Any character buffered in the DI buffer before the sequence is transmitted.

If the module cannot immediately transmit (for instance, if it is already receiving RF data), the serial data is stored in the DI Buffer. The data is packetized and sent at any RO timeout or when 100 bytes (maximum packet size) are received.

If the DI buffer becomes full, hardware or software flow control must be implemented in order to prevent overflow (loss of data between the host and module).

### 2.1.4. API Operation

API (Application Programming Interface) Operation is an alternative to the default Transparent Operation. The frame-based API extends the level to which a host application can interact with the networking capabilities of the module.

When in API mode, all data entering and leaving the module is contained in frames that define operations or events within the module.

Transmit Data Frames (received through the DI pin (pin 3)) include:

- RF Transmit Data Frame
- Command Frame (equivalent to AT commands)

Receive Data Frames (sent out the DO pin (pin 2)) include:

- Showing a received RF packet
- A response to a command
- Showing events such as reset, associate, disassociate, etc.

The API provides alternative means of configuring modules and routing data at the host application layer. A host application can send data frames to the module that contain address and payload information instead of using command mode to modify addresses. The module will send data frames to the application containing status packets; as well as source, RSSI and payload information from received data packets.

The API operation option facilitates many operations such as the examples cited below:

- > Change destination addresses without having to enter command mode
- > Receive success/failure status of each RF packet
- > Identify the source address of each received packet

To implement API operations, refer to API sections [p42].

## 2.2. IEEE 802.15.4 Networks

The following IEEE 802.15.4 network types are available to the RF module:

- NonBeacon
- NonBeacon (w/ Coordinator)

The following terms will be used to explicate the network system types:

**Table 2-01. Terms and definitions** (Applicable networking network types are designated within <brackets>.)

Term	Definition
Association	<NonBeacon (w/ Coordinator) systems only> The establishment of membership between End Devices and a Coordinator.
Coordinator	<NonBeacon (w/ Coordinator) systems only> A central RF module that is configured to provide synchronization services through the transmission of beacons.
End Device	<i>When in the same network as a Coordinator</i> - RF modules that rely on a Coordinator for synchronization and can be put into states of sleep for low-power applications.
PAN	Personal Area Network - A data communication network that includes one or more End Devices and optionally a Coordinator.

### 2.2.1. NonBeacon

By default, XBee/XBee-PRO RF Modules are configured to support NonBeacon communications (no Coordinator). NonBeacon systems operate within a Peer-to-Peer network topology and are not dependent upon Master/Slave relationships. This means that modules remain synchronized without use of master/server configurations and each module in the network shares both roles of master and slave. MaxStream's peer-to-peer architecture features fast synchronization times and fast cold start times. This default configuration accommodates a wide range of RF data applications.

**Figure 2-04. NonBeacon Peer-to-Peer Architecture**

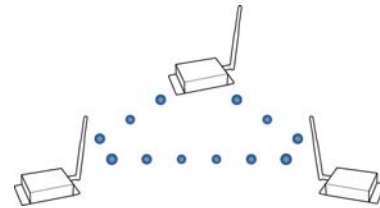

A peer-to-peer network can be established by configuring each module to operate as an End Device (CE = 0), disabling End Device Association on all modules (A1 = 0) and setting ID and CH parameters to be identical across the network.

### 2.2.2. NonBeacon (w/ Coordinator)

A device is configured as a Coordinator by setting the CE (Coordinator Enable) parameter to "1". Coordinator power-up is governed by the A2 (Coordinator Association) command.

In a NonBeacon (w/ Coordinator) system, the Coordinator can be configured to use direct or indirect transmissions. If the SP (Cyclic Sleep Period) parameter is set to "0", the Coordinator will send data immediately. Otherwise, the SP parameter determines the length of time the Coordinator will retain the data before discarding it. Generally, SP (Cyclic Sleep Period) and ST (Time before Sleep) parameters should be set to match the SP and ST settings of the End Devices.

---

Association plays a critical role in the implementation of a NonBeacon (w/ Coordinator) system. Refer to the Association section [next page] for more information.

---

### 2.2.3. Association

Association is the establishment of membership between End Devices and a Coordinator and is only applicable in NonBeacon (w/ Coordinator) networks. The establishment of membership is useful in scenarios that require a central unit (Coordinator) to relay messages to or gather data from several remote units (End Devices), assign channels or assign PAN IDs.

An RF data network that consists of one Coordinator and one or more End Devices forms a PAN (Personal Area Network). Each device in a PAN has a PAN Identifier [ID (PAN ID) parameter]. PAN IDs must be unique to prevent miscommunication between PANs. The Coordinator PAN ID is set using the ID (PAN ID) and A2 (Coordinator Association) commands.

An End Device can associate to a Coordinator without knowing the address, PAN ID or channel of the Coordinator. The A1 (End Device Association) parameter bit fields determine the flexibility of an End Device during association. The A1 parameter can be used for an End Device to dynamically set its destination address, PAN ID and/or channel.

For example: If the PAN ID of a Coordinator is known, but the operating channel is not; the A1 command on the End Device should be set to enable the 'Auto\_Associate' and 'Reassign\_Channel' bits. Additionally, the ID parameter should be set to match the PAN ID of the associated Coordinator.

#### Coordinator / End Device Setup and Operation

To configure a module to operate as a Coordinator, set the CE (Coordinator Enable) parameter to '1'. Set the CE parameter of End Devices to '0' (default). Coordinator and End Devices should contain matching firmware versions.

##### NonBeacon (w/ Coordinator) Systems

In a NonBeacon (w/ Coordinator) system, the Coordinator can be configured to use direct or indirect transmissions. If the SP (Cyclic Sleep Period) parameter is set to '0', the Coordinator will send data immediately. Otherwise, the SP parameter determines the length of time the Coordinator will retain the data before discarding it. Generally, SP (Cyclic Sleep Period) and ST (Time before Sleep) parameters should be set to match the SP and ST settings of the End Devices.

#### Coordinator Power-up

Coordinator power-up is governed by the A2 (Coordinator Association) command. On power-up, the Coordinator undergoes the following sequence of events:

##### 1. Check A2 parameter- Reassign\_PANID Flag

**Set (bit 0 = 1)** - The Coordinator issues an Active Scan. The Active Scan selects one channel and transmits a BeaconRequest command to the broadcast address (0xFFFF) and broadcast PAN ID (0xFFFF). It then listens on that channel for beacons from any Coordinator operating on that channel. The listen time on each channel is determined by the SD (Scan Duration) parameter value.

Once the time expires on that channel, the Active Scan selects another channel and again transmits the BeaconRequest as before. This process continues until all channels have been scanned, or until 5 PANs have been discovered. When the Active Scan is complete, the results include a list of PAN IDs and Channels that are being used by other PANs. This list is used to assign a unique PAN ID to the new Coordinator. The ID parameter will be retained if it is not found in the Active Scan results. Otherwise, the ID (PAN ID) parameter setting will be updated to a PAN ID that was not detected.

**Not Set (bit 0 = 0)** - The Coordinator retains its ID setting. No Active Scan is performed.

## 2. Check A2 parameter - Reassign\_Channel Flag (bit 1)

**Set (bit 1 = 1)** - The Coordinator issues an Energy Scan. The Energy Scan selects one channel and scans for energy on that channel. The duration of the scan is specified by the SD (Scan Duration) parameter. Once the scan is completed on a channel, the Energy Scan selects the next channel and begins a new scan on that channel. This process continues until all channels have been scanned.

When the Energy Scan is complete, the results include the maximal energy values detected on each channel. This list is used to determine a channel where the least energy was detected. If an Active Scan was performed (Reassign\_PANID Flag set), the channels used by the detected PANs are eliminated as possible channels. Thus, the results of the Energy Scan and the Active Scan (if performed) are used to find the best channel (channel with the least energy that is not used by any detected PAN). Once the best channel has been selected, the CH (Channel) parameter value is updated to that channel.

**Not Set (bit 1 = 0)** - The Coordinator retains its CH setting. An Energy Scan is not performed.

## 3. Start Coordinator

The Coordinator starts on the specified channel (CH parameter) and PAN ID (ID parameter). Note, these may be selected in steps 1 and/or 2 above. The Coordinator will only allow End Devices to associate to it if the A2 parameter "AllowAssociation" flag is set. Once the Coordinator has successfully started, the Associate LED will blink 1 time per second. (The LED is solid if the Coordinator has not started.)

## 4. Coordinator Changes

Once a Coordinator has started; changing the A2 (Reassign\_Channel or Reassign\_PANID bits), ID, CH or MY parameters will cause the Coordinator's MAC to reset (The Coordinator RF module (including volatile RAM) is not reset). Changing the A2 AllowAssociation bit will not reset the Coordinator's MAC. In a non-beaconing system, End Devices that associated to the Coordinator prior to a MAC reset will have knowledge of the new settings on the Coordinator. Thus, if the Coordinator were to change its ID, CH or MY settings, the End Devices would no longer be able to communicate with the non-beacon Coordinator. Once a Coordinator has started, the ID, CH, MY or A2 (Reassign\_Channel or Reassign\_PANID bits) should not be changed.

## End Device Power-up

End Device power-up is governed by the A1 (End Device Association) command. On power-up, the End Device undergoes the following sequence of events:

### 1. Check A1 parameter - AutoAssociate Bit

**Set (bit 2 = 1)** - End Device will attempt to associate to a Coordinator. (refer to steps 2-3).

**Not Set (bit 2 = 0)** - End Device will not attempt to associate to a Coordinator. The End Device will operate as specified by its ID, CH and MY parameters. Association is considered complete and the Associate LED will blink quickly (5 times per second). When the AutoAssociate bit is not set, the remaining steps (2-3) do not apply.

### 2. Discover Coordinator (if Auto-Associate Bit Set)

The End Device issues an Active Scan. The Active Scan selects one channel and transmits a BeaconRequest command to the broadcast address (0xFFFF) and broadcast PAN ID (0xFFFF). It then listens on that channel for beacons from any Coordinator operating on that channel. The listen time on each channel is determined by the SD parameter.

Once the time expires on that channel, the Active Scan selects another channel and again transmits the BeaconRequest command as before. This process continues until all channels have been scanned, or until 5 PANs have been discovered. When the Active Scan is complete, the results include a list of PAN IDs and Channels that are being used by detected PANs.

The End Device selects a Coordinator to associate with according to the A1 parameter "Reassign\_PANID" and "Reassign\_Channel" flags:

**Reassign\_PANID Bit Set (bit 0 = 1)**- End Device can associate with a PAN with any ID value.

**Reassign\_PANID Bit Not Set (bit 0 = 0)** - End Device will only associate with a PAN whose ID setting matches the ID setting of the End Device.

**Reassign\_Channel Bit Set (bit 1 = 1)** - End Device can associate with a PAN with any CH value.

**Reassign\_Channel Bit Not Set (bit 1 = 0)**- End Device will only associate with a PAN whose CH setting matches the CH setting of the End Device.

After applying these filters to the discovered Coordinators, if multiple candidate PANs exist, the End Device will select the PAN whose transmission link quality is the strongest. If no valid Coordinator is found, the End Device will either go to sleep (as dictated by its SM (Sleep Mode) parameter) or retry Association.

Note - An End Device will also disqualify Coordinators if they are not allowing association (A2 - AllowAssociation bit); or, if the Coordinator is not using the same NonBeacon scheme as the End Device. (They must both be programmed with NonBeacon code.)

### 3. Associate to Valid Coordinator

Once a valid Coordinator is found (step 2), the End Device sends an AssociationRequest message to the Coordinator. It then waits for an AssociationConfirmation to be sent from the Coordinator. Once the Confirmation is received, the End Device is Associated and the Associate LED will blink rapidly (2 times per second). The LED is solid if the End Device has not associated.

### 4. End Device Changes once an End Device has associated

Changing A1, ID or CH parameters will cause the End Device to disassociate and restart the Association procedure.

If the End Device fails to associate, the AI command can give some indication of the failure.

## 2.3. Modes of Operation

XBee/XBee-PRO RF Modules operate in five modes.

**Figure 2-05. Modes of Operation**

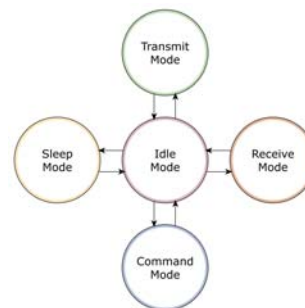

### 2.3.1. Idle Mode

When not receiving or transmitting data, the RF module is in Idle Mode. The module shifts into the other modes of operation under the following conditions:

- Transmit Mode (Serial data is received in the DI Buffer)
- Receive Mode (Valid RF data is received through the antenna)
- Sleep Mode (Sleep Mode condition is met)
- Command Mode (Command Mode Sequence is issued)

### 2.3.2. Transmit & Receive Modes

#### RF Data Packets

Each transmitted data packet contains a <Source Address> and <Destination Address> field. The <Source Address> matches the address of the transmitting module as specified by the MY (Source Address) parameter (if MY  $\geq$  0xFFFE), the SH (Serial Number High) or the SL (Serial Number Low) parameters. The <Destination Address> field is created from the DH and DL parameter values. The <Source Address> and/or <Destination Address> fields will either contain a short 16-bit or long 64-bit address.

The RF data packet structure follows the 802.15.4 specification.

[Refer to the Addressing section [p20] for more information]

#### Direct and Indirect Transmission

There are two methods to transmit data. The first method, Direct Transmission, transmits data immediately to the <Destination Address>. The second method, Indirect Transmission, retains a packet for a period of time and transmits the data only after the destination module (<RF Module Source Address> = <Data Destination Address>) requests the data. Indirect Transmissions can only occur on a Coordinator. Thus, if all devices in a network are End Devices, only Direct Transmissions will occur. Indirect Transmissions are useful to ensure packet delivery to a sleeping device. The Coordinator currently is able to retain up to 2 indirect messages.

### **Direct Transmission**

A NonBeaconing Coordinator can be configured to only use Direct Transmission by setting the SP (Cyclic Sleep Period) parameter to "0". Also, a NonBeaconing Coordinator using indirect transmissions will revert to direct transmission if it knows the destination module is awake.

To enable this behavior, the ST (Time before Sleep) value of the Coordinator must be set to match the ST value of the End Device. Once the End Device either transmits data to the Coordinator or polls the Coordinator for data, the Coordinator will use direct transmission for all subsequent data transmissions to that module address until ST time (or number of beacons) occurs with no activity (at which point it will revert to using indirect transmissions for that module address). "No activity" means no transmission or reception of messages with a specific address. Global messages will not reset the ST timer.

### **Indirect Transmission**

To configure Indirect Transmissions in a PAN (Personal Area Network), the SP (Cyclic Sleep Period) parameter value on the Coordinator must be set to match the longest sleep value of any End Device. The SP parameter represents time in NonBeacon systems and beacons in Beacon-enabled systems. The sleep period value on the Coordinator determines how long (time or number of beacons) the Coordinator will retain an indirect message before discarding it.

In NonBeacon networks, an End Device must poll the Coordinator once it wakes from Sleep to determine if the Coordinator has an indirect message for it. For Cyclic Sleep Modes, this is done automatically every time the module wakes (after SP time). For Pin Sleep Modes, the A1 (End Device Association) parameter value must be set to enable Coordinator polling on pin wake-up. Alternatively, an End Device can use the FP (Force Poll) command to poll the Coordinator as needed.

### **Transmission Algorithm**

---

Prior to transmitting a packet, a CCA (Clear Channel Assessment) is performed on the channel to determine if the channel is available for transmission. The detected energy on the channel is compared with the CA (Clear Channel Assessment) parameter value. If the detected energy exceeds the CA parameter value, the packet is not transmitted.

Also, a delay is inserted before a transmission takes place. This delay is settable using the RN (Backoff Exponent) parameter. If RN is set to "0", then there is no delay before the first CCA is performed. The RN parameter value is the equivalent of the "minBE" parameter in the 802.15.4 specification. The transmit sequence follows the 802.15.4 specification.

### **Acknowledgement**

---

If the transmission is not a broadcast message, the module will expect to receive an acknowledgement from the destination device. If an acknowledgement is not received, the packet will be resent up to 3 more times. If the acknowledgement is not received after all transmissions, an ACK failure is recorded.

### 2.3.3. Sleep Mode

Sleep Modes enable the RF module to enter states of low-power consumption when not in use. In order to enter Sleep Mode, one of the following conditions must be met (in addition to the module having a non-zero SM parameter value):

- Sleep\_RQ (pin 9) is asserted.
- The module is idle (no data transmission or reception) for the amount of time defined by the ST (Time before Sleep) parameter. [NOTE: ST is only active when SM = 4-5.]

Table 2-02. Sleep Mode Configurations

Sleep Mode Setting	Transition into Sleep Mode	Transition out of Sleep Mode (wake)	Characteristics	Related Commands	Power Consumption
Pin Hibernate (SM = 1)	Assert (high) Sleep_RQ (pin 9)	De-assert (low) Sleep_RQ	Pin/Host-controlled / NonBeacon systems only / Lowest Power	(SM)	< 10 $\mu$ A (@3.0 VCC)
Pin Doze (SM = 2)	Assert (high) Sleep_RQ (pin 9)	De-assert (low) Sleep_RQ	Pin/Host-controlled / NonBeacon systems only / Fastest wake-up	(SM)	< 50 $\mu$ A
Cyclic Sleep (SM = 4 - 5)	Automatic transition to Sleep Mode as defined by the SM (Sleep Mode) and ST (Time before Sleep) parameters.	Transition occurs after the cyclic sleep time interval elapses. The time interval is defined by the SP (Cyclic Sleep Period) parameter.	RF module wakes in pre-determined time intervals to detect if RF data is present / When SM = 5, NonBeacon systems only	(SM), SP, ST	< 50 $\mu$ A when sleeping

The SM command is central to setting Sleep Mode configurations. By default, Sleep Modes are disabled (SM = 0) and the module remains in Idle/Receive Mode. When in this state, the module is constantly ready to respond to serial or RF activity.

**Higher Voltages.** Sleep Mode current consumption is highly sensitive to voltage. Voltages above 3.0V will cause much higher current consumption.

Table 2-03. Sample Sleep Mode Currents

Vcc (V)	XBee			XBee-PRO		
	SM=1	SM=2	SM=4,5	SM=1	SM=2	SM=4,5
2.8-3.0	<3 $\mu$ A	<35 $\mu$ A	<34 $\mu$ A	<4 $\mu$ A	<34 $\mu$ A	<34 $\mu$ A
3.1	8 $\mu$ A	37 $\mu$ A	36 $\mu$ A	12 $\mu$ A	39 $\mu$ A	37 $\mu$ A
3.2	32 $\mu$ A	48 $\mu$ A	49 $\mu$ A	45 $\mu$ A	60 $\mu$ A	55 $\mu$ A
3.3	101 $\mu$ A	83 $\mu$ A	100 $\mu$ A	130 $\mu$ A	115 $\mu$ A	120 $\mu$ A
3.4	255 $\mu$ A	170 $\mu$ A	240 $\mu$ A	310 $\mu$ A	260 $\mu$ A	290 $\mu$ A

#### Pin/Host-controlled Sleep Modes

The transient current when waking from pin sleep (SM = 1 or 2) does not exceed the idle current of the module. The current ramps up exponentially to its idle current.

##### Pin Hibernate (SM = 1)

- Pin/Host-controlled
- Typical power-down current: < 10  $\mu$ A (@3.0 VCC)
- Wake-up time: 13.2 msec

Pin Hibernate Mode minimizes quiescent power (power consumed when in a state of rest or inactivity). This mode is voltage level-activated; when Sleep\_RQ is asserted, the module will finish any transmit, receive or association activities, enter Idle Mode and then enter a state of sleep. The module will not respond to either serial or RF activity while in pin sleep.

To wake a sleeping module operating in Pin Hibernate Mode, de-assert Sleep\_RQ (pin 9). The module will wake when Sleep\_RQ is de-asserted and is ready to transmit or receive when the CTS line is low. When waking the module, the pin must be de-asserted at least two 'byte times' after CTS goes low. This assures that there is time for the data to enter the DI buffer.

**Pin Doze (SM = 2)**

- Pin/Host-controlled
- Typical power-down current: < 50  $\mu$ A
- Wake-up time: 2 msec

Pin Doze Mode functions as does Pin Hibernate Mode; however, Pin Doze features faster wake-up time and higher power consumption.

To wake a sleeping module operating in Pin Doze Mode, de-assert Sleep\_RQ (pin 9). The module will wake when Sleep\_RQ is de-asserted and is ready to transmit or receive when the  $\overline{\text{CTS}}$  line is low. When waking the module, the pin must be de-asserted at least two 'byte times' after  $\overline{\text{CTS}}$  goes low. This assures that there is time for the data to enter the DI buffer.

**Cyclic Sleep Modes****Cyclic Sleep Remote (SM = 4)**

- Typical Power-down Current: < 50  $\mu$ A (when asleep)
- Wake-up time: 2 msec

The Cyclic Sleep Modes allow modules to periodically check for RF data. When the SM parameter is set to '4', the module is configured to sleep, then wakes once a cycle to check for data from a module configured as a Cyclic Sleep Coordinator (SM = 0, CE = 1). The Cyclic Sleep Remote sends a poll request to the coordinator at a specific interval set by the SP (Cyclic Sleep Period) parameter. The coordinator will transmit any queued data addressed to that specific remote upon receiving the poll request.

If no data is queued for the remote, the coordinator will not transmit and the remote will return to sleep for another cycle. If queued data is transmitted back to the remote, it will stay awake to allow for back and forth communication until the ST (Time before Sleep) timer expires.

Also note that  $\overline{\text{CTS}}$  will go low each time the remote wakes, allowing for communication initiated by the remote host if desired.

**Cyclic Sleep Remote with Pin Wake-up (SM = 5)**

Use this mode to wake a sleeping remote module through either the RF interface or by the de-assertion of Sleep\_RQ for event-driven communications. The cyclic sleep mode works as described above (Cyclic Sleep Remote) with the addition of a pin-controlled wake-up at the remote module. The Sleep\_RQ pin is edge-triggered, not level-triggered. The module will wake when a low is detected then set  $\overline{\text{CTS}}$  low as soon as it is ready to transmit or receive.

Any activity will reset the ST (Time before Sleep) timer so the module will go back to sleep only after there is no activity for the duration of the timer. Once the module wakes (pin-controlled), further pin activity is ignored. The module transitions back into sleep according to the ST time regardless of the state of the pin.

**[Cyclic Sleep Coordinator (SM = 6)]**

- Typical current = Receive current
- Always awake

---

**NOTE:** The SM=6 parameter value exists solely for backwards compatibility with firmware version 1.x60. If backwards compatibility with the older firmware version is not required, always use the CE (Coordinator Enable) command to configure a module as a Coordinator.

---

This mode configures a module to wake cyclic sleeping remotes through RF interfacing. The Coordinator will accept a message addressed to a specific remote 16 or 64-bit address and hold it in a buffer until the remote wakes and sends a poll request. Messages not sent directly (buffered and requested) are called "Indirect messages". The Coordinator only queues one indirect message at a time. The Coordinator will hold the indirect message for a period 2.5 times the sleeping period indicated by the SP (Cyclic Sleep Period) parameter. The Coordinator's SP parameter should be set to match the value used by the remotes.

### 2.3.4. Command Mode

To modify or read RF Module parameters, the module must first enter into Command Mode - a state in which incoming characters are interpreted as commands. Two Command Mode options are supported: AT Command Mode [refer to section below] and API Command Mode [p42].

#### AT Command Mode

##### To Enter AT Command Mode:

Send the 3-character command sequence “+++” and observe guard times before and after the command characters. [Refer to the “Default AT Command Mode Sequence” below.]

Default AT Command Mode Sequence (for transition to Command Mode):

- No characters sent for one second [GT (Guard Times) parameter = 0x3E8]
- Input three plus characters (“+++”) within one second [CC (Command Sequence Character) parameter = 0x2B.]
- No characters sent for one second [GT (Guard Times) parameter = 0x3E8]

All of the parameter values in the sequence can be modified to reflect user preferences.

NOTE: Failure to enter AT Command Mode is most commonly due to baud rate mismatch. Ensure the ‘Baud’ setting on the “PC Settings” tab matches the interface data rate of the RF module. By default, the BD parameter = 3 (9600 bps).

##### To Send AT Commands:

Send AT commands and parameters using the syntax shown below.

Figure 2-06. Syntax for sending AT Commands

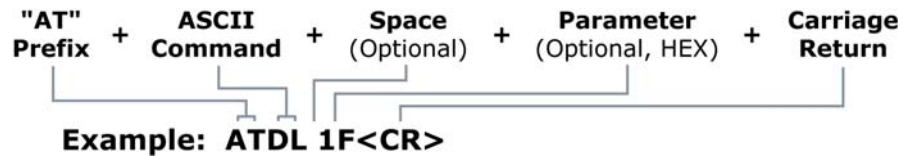

To read a parameter value stored in the RF module’s register, omit the parameter field.

The preceding example would change the RF module Destination Address (Low) to “0x1F”. To store the new value to non-volatile (long term) memory, subsequently send the WR (Write) command.

For modified parameter values to persist in the module’s registry after a reset, changes must be saved to non-volatile memory using the WR (Write) Command. Otherwise, parameters are restored to previously saved values after the module is reset.

**System Response.** When a command is sent to the module, the module will parse and execute the command. Upon successful execution of a command, the module returns an “OK” message. If execution of a command results in an error, the module returns an “ERROR” message.

##### To Exit AT Command Mode:

1. Send the ATCN (Exit Command Mode) command (followed by a carriage return).  
[OR]
2. If no valid AT Commands are received within the time specified by CT (Command Mode Timeout) Command, the RF module automatically returns to Idle Mode.

For an example of programming the RF module using AT Commands and descriptions of each configurable parameter, refer to the “RF Module Configuration” chapter [p21].

## 2.4. Addressing

Every RF data packet sent over-the-air contains a Source Address and Destination Address field in its header. The RF module conforms to the 802.15.4 specification and supports both short 16-bit addresses and long 64-bit addresses. A unique 64-bit IEEE source address is assigned at the factory and can be read with the SL (Serial Number Low) and SH (Serial Number High) commands. Short addressing must be configured manually. A module will use its unique 64-bit address as its Source Address if its MY (16-bit Source Address) value is "0xFFFF" or "0xFFFE".

To send a packet to a specific module using 64-bit addressing: Set Destination Address (DL + DH) to match the Source Address (SL + SH) of the intended destination module.

To send a packet to a specific module using 16-bit addressing: Set DL (Destination Address Low) parameter to equal the MY parameter and set the DH (Destination Address High) parameter to '0'.

### 2.4.1. Unicast Mode

By default, the RF module operates in Unicast Mode. Unicast Mode is the only mode that supports retries. While in this mode, receiving modules send an ACK (acknowledgement) of RF packet reception to the transmitter. If the transmitting module does not receive the ACK, it will re-send the packet up to three times or until the ACK is received.

**Short 16-bit addresses.** The module can be configured to use short 16-bit addresses as the Source Address by setting (MY < 0xFFFE). Setting the DH parameter (DH = 0) will configure the Destination Address to be a short 16-bit address (if DL < 0xFFFE). For two modules to communicate using short addressing, the Destination Address of the transmitter module must match the MY parameter of the receiver.

The following table shows a sample network configuration that would enable Unicast Mode communications using short 16-bit addresses.

**Table 2-04. Sample Unicast Network Configuration (using 16-bit addressing)**

Parameter	RF Module 1	RF Module 2
MY (Source Address)	0x01	0x02
DH (Destination Address High)	0	0
DL (Destination Address Low)	0x02	0x01

**Long 64-bit addresses.** The RF module's serial number (SL parameter concatenated to the SH parameter) can be used as a 64-bit source address when the MY (16-bit Source Address) parameter is disabled. When the MY parameter is disabled (set MY = 0xFFFF or 0xFFFE), the module's source address is set to the 64-bit IEEE address stored in the SH and SL parameters.

When an End Device associates to a Coordinator, its MY parameter is set to 0xFFFE to enable 64-bit addressing. The 64-bit address of the module is stored as SH and SL parameters. To send a packet to a specific module, the Destination Address (DL + DH) on one module must match the Source Address (SL + SH) of the other.

### 2.4.2. Broadcast Mode

Any RF module within range will accept a packet that contains a broadcast address. When configured to operate in Broadcast Mode, receiving modules do not send ACKs (Acknowledgements) and transmitting modules do not automatically re-send packets as is the case in Unicast Mode.

To send a broadcast packet to all modules regardless of 16-bit or 64-bit addressing, set the destination addresses of all the modules as shown below.

Sample Network Configuration (All modules in the network):

- DL (Destination Low Address) = 0x0000FFFF
- DH (Destination High Address) = 0x00000000 (default value)

**NOTE:** When programming the module, parameters are entered in hexadecimal notation (without the "0x" prefix). Leading zeros may be omitted.

# 3. RF Module Configuration

## 3.1. Programming the RF Module

Refer to the Command Mode section [p19] for more information about entering Command Mode, sending AT commands and exiting Command Mode. For information regarding module programming using API Mode, refer to the API Operation sections [p42].

### 3.1.1. Programming Examples

#### Setup

The programming examples in this section require the installation of MaxStream's X-CTU Software and a serial connection to a PC. (MaxStream stocks RS-232 and USB boards to facilitate interfacing with a PC.)

1. Install MaxStream's X-CTU Software to a PC by double-clicking the "setup\_X-CTU.exe" file. (The file is located on the MaxStream CD and under the 'Software' section of the following web page: [www.maxstream.net/support/downloads.php](http://www.maxstream.net/support/downloads.php))
2. Mount the RF module to an interface board, then connect the module assembly to a PC.
3. Launch the X-CTU Software and select the 'PC Settings' tab. Verify the baud and parity settings of the Com Port match those of the RF module.

NOTE: Failure to enter AT Command Mode is most commonly due to baud rate mismatch. Ensure the 'Baud' setting on the 'PC Settings' tab matches the interface data rate of the RF module. By default, the BD parameter = 3 (which corresponds to 9600 bps).

#### Sample Configuration: Modify RF Module Destination Address

Example: Utilize the "Terminal" tab of the X-CTU Software to change the RF module's DL (Destination Address Low) parameter and save the new address to non-volatile memory.

After establishing a serial connection between the RF module and a PC [refer to the 'Setup' section above], select the "Terminal" tab of the X-CTU Software and enter the following command lines ('CR' stands for carriage return):

Method 1 (One line per command)

<b>Send AT Command</b>	<b>System Response</b>
+++	OK <CR> (Enter into Command Mode)
ATDL <Enter>	{current value} <CR> (Read Destination Address Low)
ATDL1AOD <Enter>	OK <CR> (Modify Destination Address Low)
ATWR <Enter>	OK <CR> (Write to non-volatile memory)
ATCN <Enter>	OK <CR> (Exit Command Mode)

Method 2 (Multiple commands on one line)

<b>Send AT Command</b>	<b>System Response</b>
+++	OK <CR> (Enter into Command Mode)
ATDL <Enter>	{current value} <CR> (Read Destination Address Low)
ATDL1AOD,WR,CN <Enter>	OK, OK, OK <CR> (Command execution is triggered upon each instance of the comma)

#### Sample Configuration: Restore RF Module Defaults

Example: Utilize the X-CTU "Modem Configuration" tab to restore default parameter values.

After establishing a connection between the module and a PC [refer to the 'Setup' section above], select the "Modem Configuration" tab of the X-CTU Software.

1. Select the 'Read' button.
2. Select the 'Restore' button.

## 3.2. Command Reference Tables

XBee/XBee-PRO RF Modules expect numerical values in hexadecimal. Hexadecimal values are designated by a “0x” prefix. Decimal equivalents are designated by a “d” suffix. Table rows are sorted by command category, then by logic of most commonly used.

All modules operating within the same network should contain the same firmware version.

### Special Commands

Table 3-01. XBee-PRO Commands - Special

AT Command	Command Category	Name and Description	Parameter Range	Default
FR	Special	<b>Software Reset.</b> Responds immediately with an OK then performs a hard reset ~100ms later.	-	-
RE	Special	<b>Restore Defaults.</b> Restore module parameters to factory defaults.	-	-
WR	Special	<b>Write.</b> Write parameter values to non-volatile memory so that parameter modifications persist through subsequent power-up or reset. Note: Once WR is issued, no additional characters should be sent to the module until after the response "OK\r" is received.	-	-

### Networking Commands

Table 3-02. XBee/XBee-PRO Commands - Networking (Sub-categories designated within {brackets})

AT Command	Command Category	Name and Description	Parameter Range	Default
CH	Networking {Addressing}	<b>Channel.</b> Set/Read the channel number used for transmitting and receiving between RF modules. Uses 802.15.4 protocol channel numbers.	0x0B - 0x1A (XBee) 0x0C - 0x17 (XBee-PRO)	0x0C (12d)
ID	Networking {Addressing}	<b>PAN ID.</b> Set/Read the PAN (Personal Area Network) ID. Use 0xFFFF to send messages to all PANs.	0xFFFF	0x3332 (13106d)
DH	Networking {Addressing}	<b>Destination Address High.</b> Set/Read the upper 32 bits of the 64-bit destination address. When combined with DL, it defines the destination address used for transmission. To transmit using a 16-bit address, set DH parameter to zero and DL less than 0xFFFF. 0x0000000000000000 is the broadcast address for the PAN.	0 - 0xFFFFFFFF	0
DL	Networking {Addressing}	<b>Destination Address Low.</b> Set/Read the lower 32 bits of the 64-bit destination address. When combined with DH, DL defines the destination address used for transmission. To transmit using a 16-bit address, set DH parameter to zero and DL less than 0xFFFF. 0x0000000000000000 is the broadcast address for the PAN.	0 - 0xFFFFFFFF	0
MY	Networking {Addressing}	<b>16-bit Source Address.</b> Set/Read the RF module 16-bit source address. Set MY = 0xFFFF to disable reception of packets with 16-bit addresses. 64-bit source address (serial number) and broadcast address (0x0000000000000000) is always enabled.	0 - 0xFFFF	0
SH	Networking {Addressing}	<b>Serial Number High.</b> Read high 32 bits of the RF module's unique IEEE 64-bit address. 64-bit source address is always enabled.	0 - 0xFFFFFFFF [read-only]	Factory-set
SL	Networking {Addressing}	<b>Serial Number Low.</b> Read low 32 bits of the RF module's unique IEEE 64-bit address. 64-bit source address is always enabled.	0 - 0xFFFFFFFF [read-only]	Factory-set
RN	Networking {Addressing}	<b>Random Delay Slots.</b> Set/Read the minimum value of the back-off exponent in the CSMA-CA algorithm that is used for collision avoidance. If RN = 0, collision avoidance is disabled during the first iteration of the algorithm (802.15.4 - macMinBE).	0 - 3 [exponent]	0
MM	Networking {Addressing}	<b>MAC Mode.</b> Set/Read MAC Mode value. MAC Mode enables/disables the use of a MaxStream header in the 802.15.4 RF packet. When Mode 0 is enabled (MM=0), duplicate packet detection is enabled as well as certain AT commands. Modes 1 and 2 are strict 802.15.4 modes.	0 - 2	0
NI	Networking {Identification}	<b>Node Identifier.</b> Stores a string identifier. The register only accepts printable ASCII data. A string can not start with a space. Carriage return ends command. Command will automatically end when maximum bytes for the string have been entered. This string is returned as part of the ND (Node Discover) command. This identifier is also used with the DN (Destination Node) command.	20 byte ASCII string	-
ND	Networking {Identification}	<b>Node Discover.</b> Discovers and reports all RF modules found. The following information is reported for each module discovered (refer to long command description regarding differences between Transparent and API operation). MY<CR> SH<CR> SL<CR> DB<CR> NI<CR><CR> After NT time (2.5 seconds by default), the command ends by returning a <CR> (carriage return). ND also accepts a Node Identifier as a parameter. In this case, only a module matching the supplied identifier will respond.	optional 20 Byte NI value	-

**Table 3-02. XBee/XBee-PRO Commands - Networking** (Sub-categories designated within {brackets})

AT Command	Command Category	Name and Description	Parameter Range	Default
DN	Networking {Identification}	<b>Destination Node.</b> Resolves a Modem Identifier string to a physical address. The following events occur upon successful command execution: 1. DL and DH are set to the address of the module with the matching Modem Identifier. 2. "OK" is returned. 3. RF module automatically exits AT Command Mode If there is no response from a module within 200 msec or a parameter is not specified (left blank), the command is terminated and an "ERROR" message is returned.	20 byte ASCII string	
CE	Networking {Association}	<b>Coordinator Enable.</b> Set/Read the coordinator setting.	0 - 1 0 = End Device 1 = Coordinator	0
SC	Networking {Association}	<b>Scan Channel.</b> Set/Read list of channels to scan for all Active and Energy Scans as bit field. This affects scans initiated in command mode (AS, ED) and during End Device Association and Coordinator startup: bit 0 - 0x0B    bit 4 - 0x0F    bit 8 - 0x13    bit 12 - 0x17 bit 1 - 0x0C    bit 5 - 0x10    bit 9 - 0x14    bit 13 - 0x18 bit 2 - 0x0D    bit 6 - 0x11    bit 10 - 0x15    bit 14 - 0x19 bit 3 - 0x0E    bit 7 - 0x12    bit 11 - 0x16    bit 15 - 0x1A	0 - 0xFFFF (bit field) (bits 0, 14, 15 not allowed for XBee-PRO)	0x1FFE (all XBee-PRO Channels)
SD	Networking {Association}	<b>Scan Duration.</b> Set/Read the scan duration exponent. <b>End Device</b> - Duration of Active Scan during Association. On beacon system, set SD = BE of coordinator. SD must be set at least to the highest BE parameter of any Beaconing Coordinator with which an End Device or Coordinator wish to discover. <b>Coordinator</b> - If 'ReassignPANID' option is set on Coordinator [refer to A2 parameter], SD determines the length of time the Coordinator will scan channels to locate existing PANs. If 'ReassignChannel' option is set, SD determines how long the Coordinator will perform an Energy Scan to determine which channel it will operate on. 'Scan Time' is measured as (# of channels to scan) * (2 ^ SD) * 15.36ms). The number of channels to scan is set by the SC command. The XBee can scan up to 16 channels (SC = 0xFFFF). The XBee PRO can scan up to 13 channels (SC = 0x3FFE). Example: The values below show results for a 13 channel scan: If SD = 0, time = 0.18 sec    SD = 8, time = 47.19 sec SD = 2, time = 0.74 sec    SD = 10, time = 3.15 min SD = 4, time = 2.95 sec    SD = 12, time = 12.58 min SD = 6, time = 11.80 sec    SD = 14, time = 50.33 min	0-0x0F [exponent]	4
A1	Networking {Association}	<b>End Device Association.</b> Set/Read End Device association options. bit 0 - ReassignPanID 0 - Will only associate with Coordinator operating on PAN ID that matches module ID 1 - May associate with Coordinator operating on any PAN ID bit 1 - ReassignChannel 0 - Will only associate with Coordinator operating on Channel that matches CH setting 1 - May associate with Coordinator operating on any Channel bit 2 - AutoAssociate 0 - Device will not attempt Association 1 - Device attempts Association until success Note: This bit is used only for Non-Beacon systems. End Devices in Beacon-enabled system must always associate to a Coordinator bit 3 - PollCoordOnPinWake 0 - Pin Wake will not poll the Coordinator for indirect (pending) data 1 - Pin Wake will send Poll Request to Coordinator to extract any pending data bits 4 - 7 are reserved	0 - 0x0F [bit field]	0
A2	Networking {Association}	<b>Coordinator Association.</b> Set/Read Coordinator association options. bit 0 - ReassignPanID 0 - Coordinator will not perform Active Scan to locate available PAN ID. It will operate on ID (PAN ID). 1 - Coordinator will perform Active Scan to determine an available ID (PAN ID). If a PAN ID conflict is found, the ID parameter will change. bit 1 - ReassignChannel - 0 - Coordinator will not perform Energy Scan to determine free channel. It will operate on the channel determined by the CH parameter. 1 - Coordinator will perform Energy Scan to find a free channel, then operate on that channel. bit 2 - AllowAssociation - 0 - Coordinator will not allow any devices to associate to it. 1 - Coordinator will allow devices to associate to it. bits 3 - 7 are reserved	0 - 7 [bit field]	0

**Table 3-02. XBee/XBee-PRO Commands - Networking** (Sub-categories designated within {brackets})

AT Command	Command Category	Name and Description	Parameter Range	Default
AI	Networking {Association}	<p><b>Association Indication.</b> Read errors with the last association request:</p> <p>0x00 - Successful Completion - Coordinator successfully started or End Device association complete</p> <p>0x01 - Active Scan Timeout</p> <p>0x02 - Active Scan found no PANs</p> <p>0x03 - Active Scan found PAN, but the CoordinatorAllowAssociation bit is not set</p> <p>0x04 - Active Scan found PAN, but Coordinator and End Device are not configured to support beacons</p> <p>0x05 - Active Scan found PAN, but the Coordinator ID parameter does not match the ID parameter of the End Device</p> <p>0x06 - Active Scan found PAN, but the Coordinator CH parameter does not match the CH parameter of the End Device</p> <p>0x07 - Energy Scan Timeout</p> <p>0x08 - Coordinator start request failed</p> <p>0x09 - Coordinator could not start due to invalid parameter</p> <p>0x0A - Coordinator Realignment is in progress</p> <p>0x0B - Association Request not sent</p> <p>0x0C - Association Request timed out - no reply was received</p> <p>0x0D - Association Request had an Invalid Parameter</p> <p>0x0E - Association Request Channel Access Failure. Request was not transmitted - CCA failure</p> <p>0x0F - Remote Coordinator did not send an ACK after Association Request was sent</p> <p>0x10 - Remote Coordinator did not reply to the Association Request, but an ACK was received after sending the request</p> <p>0x11 - [reserved]</p> <p>0x12 - Sync-Loss - Lost synchronization with a Beaconing Coordinator</p> <p>0x13 - Disassociated - No longer associated to Coordinator</p>	0 - 0x13 [read-only]	-
DA	Networking {Association}	<p><b>Force Disassociation.</b> End Device will immediately disassociate from a Coordinator (if associated) and reattempt to associate.</p>	-	-
FP	Networking {Association}	<p><b>Force Poll.</b> Request indirect messages being held by a coordinator.</p>	-	-
AS	Networking {Association}	<p><b>Active Scan.</b> Sends Beacon Request to Broadcast Address (0xFFFF) and Broadcast PAN (0xFFFF) on every channel. The parameter determines the time the radio will listen for Beacons on each channel. A PanDescriptor is created and returned for every Beacon received from the scan. Each PanDescriptor contains the following information:</p> <p>CoordAddress (SH, SL)&lt;CR&gt;</p> <p>CoordPanID (ID)&lt;CR&gt;</p> <p>CoordAddrMode &lt;CR&gt;</p> <p>    0x02 = 16-bit Short Address</p> <p>    0x03 = 64-bit Long Address</p> <p>Channel (CH parameter) &lt;CR&gt;</p> <p>SecurityUse&lt;CR&gt;</p> <p>ACLEntry&lt;CR&gt;</p> <p>SecurityFailure&lt;CR&gt;</p> <p>SuperFrameSpec&lt;CR&gt; (2 bytes):</p> <p>    bit 15 - Association Permitted (MSB)</p> <p>    bit 14 - PAN Coordinator</p> <p>    bit 13 - Reserved</p> <p>    bit 12 - Battery Life Extension</p> <p>    bits 8-11 - Final CAP Slot</p> <p>    bits 4-7 - Superframe Order</p> <p>    bits 0-3 - Beacon Order</p> <p>GtsPermit&lt;CR&gt;</p> <p>RSSI&lt;CR&gt; (RSSI is returned as -dBm)</p> <p>TimeStamp&lt;CR&gt; (3 bytes)</p> <p>&lt;CR&gt;</p> <p>A carriage return &lt;CR&gt; is sent at the end of the AS command. The Active Scan is capable of returning up to 5 PanDescriptors in a scan. The actual scan time on each channel is measured as Time = [(2 ^SD PARAM) * 15.36] ms. Note the total scan time is this time multiplied by the number of channels to be scanned (16 for the XBee and 13 for the XBee-PRO). Also refer to SD command description.</p>	0 - 6	-
ED	Networking {Association}	<p><b>Energy Scan.</b> Sends Energy Detect Scan. The parameter determines length of scan on each channel. The maximal energy on each channel is returned, each value is followed by a carriage return. An additional carriage return is sent at the end of the command. The values returned represent the detected energy level in units of -dBm. The actual scan time on each channel is measured as Time = [(2 ^ED) * 15.36] ms. Note the total scan time is this time multiplied by the number of channels to be scanned. Refer to SD parameter.</p>	0 - 6	-

**RF Interfacing Commands**

**Table 3-03. XBee/XBee-PRO Commands - RF Interfacing**

AT Command	Command Category	Name and Description	Parameter Range	Default
PL	RF Interfacing	<b>Power Level.</b> Select/Read the power level at which the RF module transmits conducted power.	0 - 4	4
CA	RF Interfacing	<b>CCA Threshold.</b> Set/read the CCA (Clear Channel Assessment) threshold. Prior to transmitting a packet, a CCA is performed to detect energy on the channel. If the detected energy is above the CCA Threshold, the module will not transmit the packet.	0 - 0x50 [-dBm]	0x2C (-44d dBm)

**Serial Interfacing Commands**

**Table 3-04. XBee-PRO Commands - Serial Interfacing**

AT Command	Command Category	Name and Description	Parameter Range	Default
BD	Serial Interfacing	<b>Interface Data Rate.</b> Set/Read the serial interface data rate for communications between the RF module serial port and host.	0 - 7 (standard baud rates) 0 = 1200 bps 1 = 2400 2 = 4800 3 = 9600 4 = 19200 5 = 38400 6 = 57600 7 = 115200 0x80 - 0x1C200 (non-standard baud rates)	3
RO	Serial Interfacing	<b>Packetization Timeout.</b> Set/Read number of character times of inter-character delay required before transmission. Set to zero to transmit characters as they arrive instead of buffering them into one RF packet.	0 - 0xFF [x character times]	3
D7	Serial Interfacing	<b>DIO7 Configuration.</b> Select/Read options for the DIO7 line of the RF module.	0 - 1 0 = Disabled 1 = CTS Flow Control	1
D6	Serial Interfacing	<b>DIO6 Configuration.</b> Select/Read options for the DIO6 line of the RF module. Options include: RTS flow control.	0 - 1 0 = Disabled 1 = RTS flow control	0
D5	Serial Interfacing	<b>DIO5 Configuration.</b> Configure options for the DIO5 line of the RF module. Options include: Associated LED indicator (blinks when associated).	0 - 1 0 = Disabled 1 = Associated indicator	1
P0	Serial Interfacing	<b>PWM0 Configuration.</b> Select/Read function for PWM0.	0 - 1 0 = Disabled 1 = RSSI	1
AP	Serial Interfacing	<b>API Enable.</b> Enable API Mode.	0 - 2 0 = Disabled 1 = API enabled 2 = API enabled (w/escaped control characters)	0
PR	Serial Interfacing	<b>Pull-up Resistor Enable.</b> Set/Read bitfield to configure internal pull-up resistor status for I/O lines. bit 0 - AD4/DIO4/RF_TX bit 1 - COORD bit 2 - AD2/DIO2 bit 3 - AD1/DIO1 bit 4 - AD0/DIO0 bit 5 - RTS bit 6 - SLEEP_RQ bit 7 - DIN/CONFIG "1" specifies pull-up enabled, "0" specifies no pull-up	0 - 0xFF	0xFF

**Sleep (Low Power) Commands**

**Table 3-05. XBee/XBee-PRO Commands - Sleep (Low Power)**

AT Command	Command Category	Name and Description	Parameter Range	Default
SM	Sleep (Low Power)	<b>Sleep Mode.</b> <NonBeacon firmware> Set/Read Sleep Mode configurations.	0 - 5 0 = No Sleep 1 = Pin Hibernate 2 = Pin Doze 3 = Reserved 4 = Cyclic sleep remote 5 = Cyclic sleep remote w/ pin wake-up 6 = [Sleep Coordinator - for backwards compatibility w/ v1.x6 only; otherwise, use CE command to enable a Coordinator.]	0
SP	Sleep (Low Power)	<b>Cyclic Sleep Period.</b> <NonBeacon firmware> Set/Read sleep period for cyclic sleeping remotes. Coordinator and End Device SP values should always be equal. To send Direct Messages, set SP = 0. <i>End Device</i> - SP determines the sleep period for cyclic sleeping remotes. Maximum sleep period is 268 seconds (0x68B0). <i>Coordinator</i> - If non-zero, SP determines the time to hold an indirect message before discarding it. A Coordinator will discard indirect messages after a period of (2.5 * SP).	0 - 0x68B0 [x 10 ms]	0
DP	Sleep (Low Power)	<b>Disassociated Cyclic Sleep Period.</b> <NonBeacon firmware> <i>End Device</i> - Set/Read time period of sleep for cyclic sleeping remotes that are configured for Association but are not associated to a Coordinator. (i.e. If a device is configured to associate, configured as a Cyclic Sleep remote, but does not find a Coordinator, it will sleep for DP time before reattempting association.) Maximum sleep period is 268 seconds (0x68B0). DP should be > 0 for NonBeacon systems.	1 - 0x68B0 [x 10 ms]	0x3E8 (1000d)
ST	Sleep (Low Power)	<b>Time before Sleep.</b> <NonBeacon firmware> Set/Read time period of inactivity (no serial or RF data is sent or received) before activating Sleep Mode. ST parameter is only valid with Cyclic Sleep settings (SM = 4 - 5). Coordinator and End Device ST values must be equal. Also note, the GT parameter value must always be less than the ST value. (If GT > ST, the configuration will render the module unable to enter into command mode.) If the ST parameter is modified, also modify the GT parameter accordingly.	1 - 0xFFFF [x 1 ms]	0x1388 (5000d)

**Diagnostics Commands**

**Table 3-06. XBee/XBee-PRO Commands - Diagnostics**

AT Command	Command Category	Name and Description	Parameter Range	Default
EC	Diagnostics	<b>CCA Failures.</b> Reset/Read count of CCA (Clear Channel Assessment) failures. This parameter value increments when the module does not transmit a packet because it detected energy above the CCA threshold level set with CA command. This count saturates at its maximum value. Set count to "0" to reset count.	0 - 0xFFFF	-
EA	Diagnostics	<b>ACK Failures.</b> Reset/Read count of acknowledgment failures. This parameter value increments when the module expires its transmission retries without receiving an ACK on a packet transmission. This count saturates at its maximum value. Set the parameter to "0" to reset count.	0 - 0xFFFF	-
VR	Diagnostics	<b>Firmware Version.</b> Read firmware version of the RF module.	0 - 0xFFFF [read-only]	Factory-set
VL	Diagnostics	<b>Firmware Version - Verbose.</b> Read detailed version information (including application build date, MAC, PHY and bootloader versions).	-	-
HV	Diagnostics	<b>Hardware Version.</b> Read hardware version of the RF module.	0 - 0xFFFF [read-only]	Factory-set
RP	Diagnostics	<b>RSSI PWM Timer.</b> Enable a PWM (Pulse Width Modulation) output on pin 6 of the embedded OEM RF module which shows RX signal strength.	0 - 0xFF [x 100 ms]	0x28 (40d)
DB	Diagnostics	<b>Received Signal Strength.</b> Read signal level [in dB] of last good packet received (RSSI). Absolute value is reported. (For example: 0x58 = -88 dBm) Reported value is accurate between -40 dBm and RX sensitivity.	0 - 0x64 [read-only]	-
ED	Diagnostics	<b>Energy Scan.</b> Send an "Energy Detect Scan". This parameter determines the length of scan on each channel. The maximal energy on each channel is returned and each value is followed by a carriage return. The values returned represent the detected energy level in units of -dBm. The actual scan time on each channel is measured as Time = [(2 ^ SD PARAM) * 15.36]ms.	0 - 7	-

**AT Command Options Commands**

**Table 3-07. XBee/XBee-PRO Commands - AT Command Options**

AT Command	Command Category	Name and Description	Parameter Range	Default
CT	AT Command Mode Options	<b>Command Mode Timeout.</b> Set/Read the period of inactivity (no valid commands received) after which the RF module automatically exits AT Command Mode and returns to Idle Mode.	2 - 0xFFFF [x 100 ms]	0x64 (100d)
CN	AT Command Mode Options	<b>Exit Command Mode.</b> Explicitly exit the module from AT Command Mode.	--	--
AC	AT Command Mode Options	<b>Apply Changes.</b> Explicitly apply changes to queued parameter value(s) and re-initialize module.	--	--
GT	AT Command Mode Options	<b>Guard Times.</b> Set required period of silence before and after the Command Sequence Characters of the AT Command Mode Sequence (GT+ CC + GT). The period of silence is used to prevent inadvertent entrance into AT Command Mode.	2 - 0xFFFF [x 1 ms]	0x3E8 (1000d)
CC	AT Command Mode Options	<b>Command Sequence Character.</b> Set/Read the ASCII character value to be used between Guard Times of the AT Command Mode Sequence (GT+CC+GT). The AT Command Mode Sequence enters the RF module into AT Command Mode.	0 - 0xFF	0x2B ('+' ASCII)

### 3.3. Command Descriptions

Command descriptions in this section are listed alphabetically. Command categories are designated within "< >" symbols that follow each command title. XBee/XBee-PRO RF Modules expect parameter values in hexadecimal (designated by the "0x" prefix).

All modules operating within the same network should contain the same firmware version.

#### A1 (End Device Association) Command

<Networking {Association}> The A1 command is used to set and read association options for and End Device.

Use the table below to determine End Device behavior in relation to the A1 parameter.

AT Command: ATA1

Parameter Range: 0 – 0x0F [bitfield]

Default Parameter Value: 0

Related Commands: ID (PAN ID), NI (Node Identifier), CH (Channel), CE (Coordinator Enable), A2 (Coordinator Association)

Bit number	End Device Association Option
0 - ReassignPanID	0 - Will only associate with Coordinator operating on PAN ID that matches Node Identifier
	1 - May associate with Coordinator operating on any PAN ID
1 - ReassignChannel	0 - Will only associate with Coordinator operating on Channel that matches CH setting
	1 - May associate with Coordinator operating on any Channel
2 - AutoAssociate	0 - Device will not attempt Association
	1 - Device attempts Association until success Note: This bit is used only for Non-Beacon systems. End Devices in a Beaconing system must always associate to a Coordinator
3 - PollCoordOnPinWake	0 - Pin Wake will not poll the Coordinator for pending (indirect) Data
	1 - Pin Wake will send Poll Request to Coordinator to extract any pending data
4 - 7	[reserved]

#### A2 (Coordinator Association) Command

<Networking {Association}> The A2 command is used to set and read association options of the Coordinator.

Use the table below to determine Coordinator behavior in relation to the A2 parameter.

AT Command: ATA2

Parameter Range: 0 – 7 [bitfield]

Default Parameter Value: 0

Related Commands: ID (PAN ID), NI (Node Identifier), CH (Channel), CE (Coordinator Enable), A1 (End Device Association), AS (Active Scan), ED (Energy Scan)

Bit number	End Device Association Option
0 - ReassignPanID	0 - Coordinator will not perform Active Scan to locate available PAN ID. It will operate on ID (PAN ID).
	1 - Coordinator will perform Active Scan to determine an available ID (PAN ID). If a PAN ID conflict is found, the ID parameter will change.
1 - ReassignChannel	0 - Coordinator will not perform Energy Scan to determine free channel. It will operate on the channel determined by the CH parameter.
	1 - Coordinator will perform Energy Scan to find a free channel, then operate on that channel.
2 - AllowAssociate	0 - Coordinator will not allow any devices to associate to it.
	1 - Coordinator will allow devices to associate to it.
3 - 7	[reserved]

The binary equivalent of the default value (0x06) is 00000110. 'Bit 0' is the last digit of the sequence.

**AC (Apply Changes) Command**

<AT Command Mode Options> The AC command is used to explicitly apply changes to module parameter values. 'Applying changes' means that the module is re-initialized based on changes made to its parameter values. Once changes are applied, the modem immediately operates according to the new parameter values.

**AT Command: ATAC**

This behavior contrasts issuing the WR (Write) command. The WR command saves parameter values to non-volatile memory, but the module still operates according to previously saved values until the module is re-booted or the CN (Exit AT Command Mode) command is issued.

Refer to the "AT Command - Queue Parameter Value" API type for more information [p44].

**AI (Association Indication) Command**

<Networking {Association}> The AI command is used to indicate occurrences of errors during the last association request.

**AT Command: ATAI**

**Parameter Range: 0 – 0x13 [read-only]**

Use the table below to determine meaning of the returned values.

**Related Commands: AS (Active Scan), ID (PAN ID), CH (Channel), ED (Energy Scan), A1 (End Device Association), A2 (Coordinator Association), CE (Coordinator Enable)**

Returned Value (Hex)	Association Indication
0x00	Successful Completion - Coordinator successfully started or End Device association complete
0x01	Active Scan Timeout
0x02	Active Scan found no PANs
0x03	Active Scan found PAN, but the Coordinator Allow Association bit is not set
0x04	Active Scan found PAN, but Coordinator and End Device are not configured to support beacons
0x05	Active Scan found PAN, but Coordinator ID (PAN ID) value does not match the ID of the End Device
0x06	Active Scan found PAN, but Coordinator CH (Channel) value does not match the CH of the End Device
0x07	Energy Scan Timeout
0x08	Coordinator start request failed
0x09	Coordinator could not start due to Invalid Parameter
0x0A	Coordinator Realignment is in progress
0x0B	Association Request not sent
0x0C	Association Request timed out - no reply was received
0x0D	Association Request had an Invalid Parameter
0x0E	Association Request Channel Access Failure - Request was not transmitted - CCA failure
0x0F	Remote Coordinator did not send an ACK after Association Request was sent
0x10	Remote Coordinator did not reply to the Association Request, but an ACK was received after sending the request
0x11	[reserved]
0x12	Sync-Loss - Lost synchronization with a Beaconsing Coordinator
0x13	Disassociated - No longer associated to Coordinator

**AP (API Enable) Command**

<Serial Interfacing> The AP command is used to enable the RF module to operate using a frame-based API.

**AT Command: ATAP**

**Parameter Range: 0 – 2**

Parameter	Configuration
0	Disabled (UART operation)
1	API enabled
2	API enabled (with escaped characters)

**Default Parameter Value: 0**

Refer to the API Operation section [p42] when API operation is enabled (AP = 1 or 2).

**AS (Active Scan) Command**

<AT Command Mode Options> The AS command is used to send a Beacon Request to a Broadcast Address (0xFFFF) and Broadcast PAN (0xFFFF) on every channel. The parameter determines the amount of time the RF module will listen for Beacons on each channel. A 'PanDescriptor' is created and returned for every Beacon received from the scan. Each PanDescriptor contains the following information:

CoordAddress (SH + SL parameters)<CR>  
 CoordPanID (ID parameter)<CR>  
 CoordAddrMode <CR>  
     0x02 = 16-bit Short Address  
     0x03 = 64-bit Long Address  
 Channel (CH parameter) <CR>  
 SecurityUse<CR>  
 ACLEntry<CR>  
 SecurityFailure<CR>  
 SuperFrameSpec<CR> (2 bytes):  
     bit 15 - Association Permitted (MSB)  
     bit 14 - PAN Coordinator  
     bit 13 - Reserved  
     bit 12 - Battery Life Extension  
     bits 8-11 - Final CAP Slot  
     bits 4-7 - Superframe Order  
     bits 0-3 - Beacon Order  
 GtsPermit<CR>  
 RSSI<CR> (- RSSI is returned as -dBm)  
 TimeStamp<CR> (3 bytes)  
 <CR> (A carriage return <CR> is sent at the end of the AS command.

AT Command: ATAS

Parameter Range: 0 – 6

Related Command: SD (Scan Duration), DL (Destination Low Address), DH (Destination High Address), ID (PAN ID), CH (Channel)

The Active Scan is capable of returning up to 5 PanDescriptors in a scan. The actual scan time on each channel is measured as Time = [(2 ^ (SD Parameter)) \* 15.36] ms. Total scan time is this time multiplied by the number of channels to be scanned (16 for the XBee, 12 for the XBee-PRO).

NOTES: Refer the scan table in the SD description [p39] to determine scan times. If using API Mode, no <CR>'s are returned in the response. Refer to the API Mode Operation section [p42].

**BD (Interface Data Rate) Command**

<Serial Interfacing> The BD command is used to set and read the serial interface data rate used between the RF module and host. This parameter determines the rate at which serial data is sent to the module from the host. Modified interface data rates do not take effect until the CN (Exit AT Command Mode) command is issued and the system returns the 'OK' response.

When parameters 0-7 are sent to the module, the respective interface data rates are used (as shown in the table on the right).

The RF data rate is not affected by the BD parameter. If the interface data rate is set higher than the RF data rate, a flow control configuration may need to be implemented.

AT Command: ATBD

Parameter Range: 0 – 7 (standard rates)  
 0x80–0x1C200 (non-stdnd rates)

Parameter	Configuration (bps)
0	1200
1	2400
2	4800
3	9600
4	19200
5	38400
6	57600
7	115200

Default Parameter Value:3

**Non-standard Interface Data Rates:**

Any value above 0x07 will be interpreted as an actual baud rate. When a value above 0x07 is sent, the closest interface data rate represented by the number is stored in the BD register. For example, a rate of 19200 bps can be set by sending the following command line "ATBD4B00". NOTE: When using MaxStream's X-CTU Software, non-standard interface data rates can only be set and read using the X-CTU 'Terminal' tab. Non-standard rates are not accessible through the 'Modem Configuration' tab.

When the BD command is sent with a non-standard interface data rate, the UART will adjust to accommodate the requested interface rate. In most cases, the clock resolution will cause the stored BD parameter to vary from the parameter that was sent (refer to the table below). Reading the BD command (send "ATBD" command without an associated parameter value) will return the value actually stored in the module's BD register.

**Parameters Sent Versus Parameters Stored**

BD Parameter Sent (HEX)	Interface Data Rate (bps)	BD Parameter Stored (HEX)
0	1200	0
4	19,200	4
7	115,200	7
12C	300	12B
1C200	115,200	1B207

**CA (CCA Threshold) Command**

<RF Interfacing> CA command is used to set and read CCA (Clear Channel Assessment) thresholds. Prior to transmitting a packet, a CCA is performed to detect energy on the transmit channel. If the detected energy is above the CCA Threshold, the RF module will not transmit the packet.

AT Command: ATCA

Parameter Range: 0 – 0x50 [-dBm]

Default Parameter Value: 0x2C  
(-44 decimal dBm)

**CC (Command Sequence Character) Command**

<AT Command Mode Options> The CC command is used to set and read the ASCII character used between guard times of the AT Command Mode Sequence (GT + CC + GT). This sequence enters the RF module into AT Command Mode so that data entering the module from the host is recognized as commands instead of payload.

AT Command: ATCC

Parameter Range: 0 – 0xFF

Default Parameter Value: 0x2B (ASCII "+")

Related Command: GT (Guard Times)

The AT Command Sequence is discussed further in the AT Command Mode section [p19].

**CE (Coordinator Enable) Command**

<Serial Interfacing> The CE command is used to set and read the behavior (End Device vs. Coordinator) of the RF module.

AT Command: ATCE

Parameter Range: 0 – 1

Parameter	Configuration
0	End Device
1	Coordinator

Default Parameter Value: 0

**CH (Channel) Command**

<Networking {Addressing}> The CH command is used to set and read the channel on which RF connections are made between RF modules. The channel is one of three filtration options available to the module. The other options are the PAN ID (ID command) and destination addresses (DL & DH commands).

In order for modules to communicate with each other, the modules must share the same channel number. Different channels can be used to prevent modules in one network from listening to transmissions of another.

The module uses channel numbers of the 802.15.4 standard.

$$\text{Center Frequency} = 2.405 + (\text{CH} - 11d) * 5 \text{ MHz} \quad (d = \text{decimal})$$

AT Command: ATCH

Parameter Range: 0x0B – 0x1A (XBee)  
0x0C – 0x17 (XBee-PRO)

Default Parameter Value: 0x0C (12 decimal)

Related Commands: ID (PAN ID), DL (Destination Address Low, DH (Destination Address High)

Refer to the Addressing section [p20] for more information.

**CN (Exit Command Mode) Command**

<AT Command Mode Options> The CN command is used to explicitly exit the RF module from AT Command Mode.

AT Command: ATCN

**CT (Command Mode Timeout) Command**

<AT Command Mode Options> The CT command is used to set and read the amount of inactive time that elapses before the RF module automatically exits from AT Command Mode and returns to Idle Mode.

Use the CN (Exit AT Command Mode) command to exit AT Command Mode manually.

AT Command: ATCT

Parameter Range: 2 – 0xFFFF  
[x 100 milliseconds]

Default Parameter Value: 0x64 (100 decimal (which equals 10 decimal seconds))

Number of bytes returned: 2

Related Command: CN (Exit AT Command Mode)

**D5 (DIO5 Configuration) Command**

<Serial Interfacing> The D5 command is used to configure options for the DIO5 line of the RF module. When the D5 parameter is set to “1”, the D5 line is used to indicate “Association (membership with another module)” by causing the LED indicator to blink.

AT Command: ATD5

Parameter Range: 0 – 1

Parameter	Configuration
0	Disabled
1	Association Indicator

Default Parameter Value: 1

**D6 (DIO6 Configuration) Command**

<Serial Interfacing> The D6 command is used to set and read the behavior of the DIO6 line. This line can be configured to enable RTS flow control.

AT Command: ATD6

Parameter Range: 0 – 1

Parameter	Configuration
0	Disabled
1	RTS Flow Control

Default Parameter Value: 0

**D7 (DIO7 Configuration) Command**

<Serial Interfacing> The D7 command is used to set and read the behavior of the DIO7 line. CTS flow control is enabled by default.

AT Command: ATD7

Parameter Range: 0 – 1

Parameter	Configuration
0	Disabled
1	CTS Flow Control

Default Parameter Value: 1

**DA (Force Disassociation) Command**

<(Special)> The DA command is used to immediately disassociate an End Device from a Coordinator and reattempt to associate.

AT Command: ATDA

**DB (Received Signal Strength) Command**

<Diagnostics> DB parameter is used to read the received signal strength (in dBm) of the last RF packet received. Reported values are accurate between -40 dBm and the RF module's receiver sensitivity.

AT Command: ATDB

Parameter Range: 0 – 0x64 [read-only]

Absolute values are reported. For example: 0x58 = -88 dBm (decimal). If no packets have been received (since last reset, power cycle or sleep event), "0" will be reported.

**DH (Destination Address High) Command**

<Networking {Addressing}> The DH command is used to set and read the upper 32 bits of the RF module's 64-bit destination address. When combined with the DL (Destination Address Low) parameter, it defines the destination address used for transmission.

AT Command: ATDH

Parameter Range: 0 – 0xFFFFFFFF

Default Parameter Value: 0

Related Commands: DL (Destination Address Low), CH (Channel), ID (PAN VID), MY (Source Address)

An module will only communicate with other modules having the same channel (CH parameter), PAN ID (ID parameter) and destination address (DH + DL parameters).

To transmit using a 16-bit address, set the DH parameter to zero and the DL parameter less than 0xFFFF. 0x00000000000000FFFF (DL concatenated to DH) is the broadcast address for the PAN.

Refer to the Addressing section [p20] for more information.

**DL (Destination Address Low) Command**

<Networking {Addressing}> The DL command is used to set and read the lower 32 bits of the RF module's 64-bit destination address. When combined with the DH (Destination Address High) parameter, it defines the destination address used for transmission.

AT Command: ATDL

Parameter Range: 0 - 0xFFFFFFFF

Default Parameter Value: 0

Related Commands: DH (Destination Address High), CH (Channel), ID (PAN VID), MY (Source Address)

A module will only communicate with other modules having the same channel (CH parameter), PAN ID (ID parameter) and destination address (DH + DL parameters).

To transmit using a 16-bit address, set the DH parameter to zero and the DL parameter less than 0xFFFF. 0x00000000000000FFFF (DL concatenated to DH) is the broadcast address for the PAN.

Refer to the Addressing section [p20] for more information.

### DN (Destination Node) Command

<Networking {Identification}> The DN command is used to resolve a NI (Node Identifier) string to a physical address. The following events occur upon successful command execution:

1. DL and DH are set to the address of the module with the matching NI (Node Identifier).
2. 'OK' is returned.
3. RF module automatically exits AT Command Mode.

If there is no response from a modem within 200 msec or a parameter is not specified (left blank), the command is terminated and an 'ERROR' message is returned.

AT Command: ATDN

Parameter Range: 20-character ASCII String

### DP (Disassociation Cyclic Sleep Period) Command

<Sleep Mode (Low Power)>

#### NonBeacon Firmware

*End Device* - The DP command is used to set and read the time period of sleep for cyclic sleeping remotes that are configured for Association but are not associated to a Coordinator. (i.e. If a device is configured to associate, configured as a Cyclic Sleep remote, but does not find a Coordinator; it will sleep for DP time before reattempting association.) Maximum sleep period is 268 seconds (0x68B0). DP should be > 0 for NonBeacon systems.

AT Command: ATDP

Parameter Range: 1 – 0x68B0  
[x 10 milliseconds]

Default Parameter Value: 0x3E8  
(1000 decimal)

Related Commands: SM (Sleep Mode), SP (Cyclic Sleep Period), ST (Time before Sleep)

### EA (ACK Failures) Command

<Diagnostics> The EA command is used to reset and read the count of ACK (acknowledgement) failures. This parameter value increments when the module expires its transmission retries without receiving an ACK on a packet transmission. This count saturates at its maximum value.

Set the parameter to "0" to reset count.

AT Command: ATEA

Parameter Range: 0 – 0xFFFF

### EC (CCA Failures) Command

<Diagnostics> The EC command is used to read and reset the count of CCA (Clear Channel Assessment) failures. This parameter value increments when the RF module does not transmit a packet due to the detection of energy that is above the CCA threshold level (set with CA command). This count saturates at its maximum value.

Set the EC parameter to "0" to reset count.

AT Command: ATEC

Parameter Range: 0 – 0xFFFF

Related Command: CA (CCA Threshold)

### ED (Energy Scan) Command

<Networking {Association}> The ED command is used to send an "Energy Detect Scan". This parameter determines the length of scan on each channel. The maximal energy on each channel is returned and each value is followed by a carriage return. An additional carriage return is sent at the end of the command.

The values returned represent the detected energy level in units of -dBm. The actual scan time on each channel is measured as  $Time = [(2 \wedge ED \text{ PARAM}) * 15.36] \text{ ms}$ .

AT Command: ATED

Parameter Range: 0 – 6

Related Command: SD (Scan Duration), SC (Scan Channel)

Note: Total scan time is this time multiplied by the number of channels to be scanned. Also refer to the SD (Scan Duration) table. Use the SC (Scan Channel) command to choose which channels to scan.

**FP (Force Poll) Command**

<Networking (Association)> The FP command is used to request indirect messages being held by a Coordinator.

AT Command: ATFP

**FR (Software Reset) Command**

<Special> The FR command is used to force a software reset on the RF module. The reset simulates powering off and then on again the module.

AT Command: ATFR

**GT (Guard Times) Command**

<AT Command Mode Options> GT Command is used to set the DI (data in from host) time-of-silence that surrounds the AT command sequence character (CC Command) of the AT Command Mode sequence (GT + CC + GT).

The DI time-of-silence is used to prevent inadvertent entrance into AT Command Mode.

Refer to the Command Mode section [p19] for more information regarding the AT Command Mode Sequence.

AT Command: ATGT

Parameter Range: 2 – 0xFFFF  
[x 1 millisecond]

Default Parameter Value: 0x3E8  
(1000 decimal)

Related Command: CC (Command Sequence Character)

**HV (Hardware Version) Command**

<Diagnostics> The HV command is used to read the hardware version of the RF module.

AT Command: ATHV

Parameter Range: 0 – 0xFFFF [Read-only]

**ID (Pan ID) Command**

<Networking {Addressing}> The ID command is used to set and read the PAN (Personal Area Network) ID of the RF module. Only modules with matching PAN IDs can communicate with each other. Unique PAN IDs enable control of which RF packets are received by a module.

Setting the ID parameter to 0xFFFF indicates a global transmission for all PANs. It does not indicate a global receive.

AT Command: ATID

Parameter Range: 0 – 0xFFFF

Default Parameter Value: 0x3332  
(13106 decimal)

**MM (MAC Mode) Command**

<Networking {Addressing}> The MM command is used to set and read the MAC Mode value. The MM command disables/enables the use of a MaxStream header contained in the 802.15.4 RF packet. By default (MM = 0), MaxStream Mode is enabled and the module adds an extra header to the data portion of the 802.15.4 packet. Duplicate packet detection is enabled as well as certain AT commands.

Modes 1 and 2 are strict 802.15.4 modes. If the MaxStream header is disabled, the ND (Node Discover) and DN (Destination Node) parameters are also disabled.

AT Command: ATMM

Parameter Range: 0 – 2

Parameter	Configuration
0	MaxStream Mode (802.15.4 + MaxStream header)
1	802.15.4 (no ACKs)
2	802.15.4 (with ACKs)

Default Parameter Value: 0

### MY (16-bit Source Address) Command

<Networking {Addressing}> The MY command is used to set and read the 16-bit source address of the RF module.

By setting MY to 0xFFFF, the reception of RF packets having a 16-bit address is disabled. The 64-bit address is the module's serial number and is always enabled.

Refer to the Addressing section [p20] for more information.

AT Command: ATMY

Parameter Range: 0 – 0xFFFF

Default Parameter Value: 0

Related Commands: DH (Destination Address High), DL (Destination Address Low), CH (Channel), ID (PAN ID)

### ND (Node Discover) Command

<Networking {Identification}> The ND command is used to discover and report all RF modules on its current Operating Channel (CH parameter) and PAN ID (ID parameter). ND also accepts an NI (Node Identifier) value as a parameter. In this case, only a module matching the supplied identifier will respond.

The ND command causes a module to transmit a globally addressed ND command packet. The amount of time allowed for responses is 2.5 seconds which is enough time to receive all responses.

In AT Command mode, command completion is designated by a carriage return (0x0D). Since two carriage returns end a command response, the application will receive three carriage returns at the end of the command. If no responses are received, the application should only receive one carriage return. When in API mode, the application should receive a frame (with no data) and status (set to 'OK') at the end of the command. When the ND command packet is received, the remote sets up a random time delay of 2.5 seconds before replying with a ND response as follows:

Node Discover Response (AT command mode format):

```
MY (Source Address) value<CR>
SH (Serial Number High) value<CR>
SL (Serial Number Low) value<CR>
DB (Received Signal Strength) value<CR>
NI (Node Identifier) value<CR>
<CR> (This is part of the response and not the end of command indicator.)
```

Node Discover Response (API format - data is binary (except for NI)):

```
2 bytes for MY (Source Address) value
4 bytes for SH (Serial Number High) value
4 bytes for SL (Serial Number Low) value
1 byte for DB (Received Signal Strength) value
NULL-terminated string for NI (Node Identifier) value (max 20 bytes w/out NULL terminator)
```

### NI (Node Identifier) Command

<Networking {Identification}> The NI command is used to set and read a string for identifying a particular node.

Rules:

- Register only accepts printable ASCII data.
- A string can not start with a space.
- A carriage return ends command
- Command will automatically end when maximum bytes for the string have been entered.

This string is returned as part of the ND (Node Discover) command. This identifier is also used with the DN (Destination Node) command.

AT Command: ATNI

Parameter Range: 20-character ASCII string

Related Commands: ND (Node Discover), DN (Destination Node)

**P0 (PWM0 Configuration) Command**

<Diagnostics> The P0 command is used to select and read the function for PWM0 (Pulse Width Modulation output 0 - pin 6).

Note: The second character in the command is a zero ("0"), not the letter "O".

AT Command: ATPO

Parameter Range: 0 – 1

Parameter	Configuration
0	Disabled
1	RSSI PWM0 enabled

Default Parameter Value: 1

**PL (Power Level) Command**

<RF Interfacing> The PL command is used to select and read the power level at which the RF module transmits conducted power.

WHEN OPERATING IN EUROPE:

XBee-PRO RF Modules must be configured to operate at a maximum transmit power output level of 10 dBm. The PL parameter must equal "0" (10 dBm).

Additionally, European regulations stipulate an EIRP power maximum of 12.86 dBm (19 mW) for the XBee-PRO and 12.11 dBm for the XBee when integrating high-gain antennas.

AT Command: ATPL

Parameter Range: 0 – 4

Parameter	XBee	XBee-Pro
0	-10 dBm	10 dBm
1	-6 dBm	12 dBm
2	-4 dBm	14 dBm
3	-2 dBm	16 dBm
4	0 dBm	18 dBm

Default Parameter Value: 4

**PR (Pull-up Resistor Enable) Command**

<Serial Interfacing> The PR command is used to set and read the bit field that is used to configure internal the pull-up resistor status for I/O lines. "1" specifies the pull-up resistor is enabled. "0" specifies no pull up.

- bit 0 - AD4/DIO4 (pin 11)
- bit 1 - AD3/DIO3 (pin 17)
- bit 2 - AD2/DIO2 (pin 18)
- bit 3 - AD1/DIO1 (pin 19)
- bit 4 - AD0/DIO0 (pin 20)
- bit 5 - AD6/DIO6 (pin 16)
- bit 6 - DI8 (pin 9)
- bit 7 - DIN/CONFIG (pin 3)

For example: Sending the command "ATPR 6F" will turn bits 0, 1, 2, 3, 5 and 6 ON; and bits 4 & 7 will be turned OFF. (The binary equivalent of "0x6F" is "01101111". Note that 'bit 0' is the last digit in the bitfield.

AT Command: ATPR

Parameter Range: 0 – 0xFF

Default Parameter Value: 0xFF  
(all pull-up resistors are enabled)

**RE (Restore Defaults) Command**

<(Special)> The RE command is used to restore all configurable parameters to their factory default settings. The RE command does not write restored values to non-volatile (persistent) memory. Issue the WR (Write) command subsequent to issuing the RE command to save restored parameter values to non-volatile memory.

AT Command: ATRE

**RN (Random Delay Slots) Command**

<Networking & Security> The RN command is used to set and read the minimum value of the back-off exponent in the CSMA-CA algorithm. The CSMA-CA algorithm was engineered for collision avoidance (random delays are inserted to prevent data loss caused by data collisions).

If RN = 0, collision avoidance is disabled during the first iteration of the algorithm (802.15.4 - macMinBE).

CSMA-CA stands for "Carrier Sense Multiple Access - Collision Avoidance". Unlike CSMA-CD (reacts to network transmissions after collisions have been detected), CSMA-CA acts to prevent data collisions before they occur. As soon as a module receives a packet that is to be transmitted, it checks if the channel is clear (no other module is transmitting). If the channel is clear, the packet is sent over-the-air. If the channel is not clear, the module waits for a randomly selected period of time, then checks again to see if the channel is clear. After a time, the process ends and the data is lost.

AT Command: ATRN  
 Parameter Range: 0 – 3 [exponent]  
 Default Parameter Value: 0

**RO (Packetization Timeout) Command**

<Serial Interfacing> RO command is used to set and read the number of character times of inter-character delay required before transmission.

RF transmission commences when data is detected in the DI (data in from host) buffer and RO character times of silence are detected on the UART receive lines (after receiving at least 1 byte).

RF transmission will also commence after 100 bytes (maximum packet size) are received in the DI buffer.

Set the RO parameter to '0' to transmit characters as they arrive instead of buffering them into one RF packet.

AT Command: ATRO  
 Parameter Range: 0 – 0xFF  
 [x character times]  
 Default Parameter Value: 3

**RP (RSSI PWM Timer) Command**

<Diagnostics> The RP command is used to enable PWM (Pulse Width Modulation) output on the RF module. The output is calibrated to show the level a received RF signal is above the sensitivity level of the module. The PWM pulses vary from 24 to 100%. Zero percent means PWM output is inactive. One to 24% percent means the received RF signal is at or below the published sensitivity level of the module. The following table shows levels above sensitivity and PWM values.

The total period of the PWM output is 64 μs. Because there are 445 steps in the PWM output, the minimum step size is 144 ns.

**PWM Percentages**

dB above Sensitivity	PWM percentage (high period / total period)
10	41%
20	58%
30	75%

A non-zero value defines the time that the PWM output will be active with the RSSI value of the last received RF packet. After the set time when no RF packets are received, the PWM output will be set low (0 percent PWM) until another RF packet is received. The PWM output will also be set low at power-up until the first RF packet is received. A parameter value of 0xFF permanently enables the PWM output and it will always reflect the value of the last received RF packet.

AT Command: ATRP  
 Parameter Range: 0 – 0xFF  
 [x 100 msec]  
 Default Parameter Value: 0x28 (40 decimal)

### SC (Scan Channel) Command

<RF Interfacing> The SC command is used to set and read the list of channels to scan for all Active and Energy Scans as a bit field.

This affects scans initiated in command mode [AS (Active Scan) and ED (Energy Scan) commands] and during End Device Association and Coordinator startup.

bit 0 - 0x0B	bit 4 - 0x0F	bit 8 - 0x13	bit 12 - 0x17
bit 1 - 0x0C	bit 5 - 0x10	bit 9 - 0x14	bit 13 - 0x18
bit 2 - 0x0D	bit 6 - 0x11	bit 10 - 0x15	bit 14 - 0x19
bit 3 - 0x0E	bit 7 - 0x12	bit 11 - 0x16	bit 15 - 0x1A

AT Command: ATSC

Parameter Range: 0 – 0xFFFF [Bitfield] (bits 0, 14, 15 are not allowed when using the XBee-PRO)

Default Parameter Value: 0x1FFE (all XBee-PRO channels)

Related Commands: ED (Energy Scan), SD (Scan Duration)

### SD (Scan Duration) Command

<Networking {Association}> The SD command is used to set and read the exponent value that determines the duration (in time) of a scan.

**End Device** (Duration of Active Scan during Association) - In a Beacon system, set SD = BE of the Coordinator. SD must be set at least to the highest BE parameter of any Beaconsing Coordinator with which an End Device or Coordinator wish to discover.

**Coordinator** - If the 'ReassignPANID' option is set on the Coordinator [refer to A2 parameter], the SD parameter determines the length of time the Coordinator will scan channels to locate existing PANs. If the 'ReassignChannel' option is set, SD determines how long the Coordinator will perform an Energy Scan to determine which channel it will operate on.

Scan Time is measured as ((# of Channels to Scan) \* (2 ^ SD) \* 15.36ms). The number of channels to scan is set by the SC command. The XBee RF Module can scan up to 16 channels (SC = 0xFFFF). The XBee PRO RF Module can scan up to 12 channels (SC = 0x1FFE).

**Examples: Values below show results for a 12-channel scan**

If SD = 0, time = 0.18 sec	SD = 8, time = 47.19 sec
SD = 2, time = 0.74 sec	SD = 10, time = 3.15 min
SD = 4, time = 2.95 sec	SD = 12, time = 12.58 min
SD = 6, time = 11.80 sec	SD = 14, time = 50.33 min

AT Command: ATSD

Parameter Range: 0 – 0x0F

Default Parameter Value: 4

Related Commands: ED (Energy Scan), SC (Scan Channel)

### SH (Serial Number High) Command

<Diagnostics> The SH command is used to read the high 32 bits of the RF module's unique IEEE 64-bit address.

The module serial number is set at the factory and is read-only.

AT Command: ATSH

Parameter Range: 0 – 0xFFFFFFFF [read-only]

Related Commands: SL (Serial Number Low), MY (Source Address)

### SL (Serial Number Low) Command

<Diagnostics> The SL command is used to read the low 32 bits of the RF module's unique IEEE 64-bit address.

The module serial number is set at the factory and is read-only.

AT Command: ATSL

Parameter Range: 0 – 0xFFFFFFFF [read-only]

Related Commands: SH (Serial Number High), MY (Source Address)

**SM (Sleep Mode) Command**

<Sleep Mode (Low Power)> The SM command is used to set and read Sleep Mode settings. By default, Sleep Modes are disabled (SM = 0) and the RF module remains in Idle/Receive Mode. When in this state, the module is constantly ready to respond to either serial or RF activity.

SM command options vary according to the networking system type. By default, the module is configured to operate in a NonBeacon system.

\* The Sleep Coordinator option (SM=6) only exists for backwards compatibility with firmware version 1.x06 only. In all other cases, use the CE command to enable a Coordinator.

AT Command: ATSM

Parameter Range: 0 – 6

Parameter	Configuration
0	Disabled
1	Pin Hibernate
2	Pin Doze
3	(reserved)
4	Cyclic Sleep Remote
5	Cyclic Sleep Remote (with Pin Wake-up)
6	Sleep Coordinator*

Default Parameter Value: 0

Related Commands: SP (Cyclic Sleep Period), ST (Time before Sleep)

**SP (Cyclic Sleep Period) Command**

<Sleep Mode (Low Power)> The SP command is used to set and read the duration of time in which a remote RF module sleeps. After the cyclic sleep period is over, the module wakes and checks for data. If data is not present, the module goes back to sleep. The maximum sleep period is 268 seconds (SP = 0x68B0).

The SP parameter is only valid if the module is configured to operate in Cyclic Sleep (SM = 4-6). Coordinator and End Device SP values should always be equal.

To send Direct Messages, set SP = 0.

**NonBeacon Firmware**

*End Device* - SP determines the sleep period for cyclic sleeping remotes. Maximum sleep period is 268 seconds (0x68B0).

*Coordinator* - If non-zero, SP determines the time to hold an indirect message before discarding it. A Coordinator will discard indirect messages after a period of (2.5 \* SP).

AT Command: ATSP

Parameter Range: NonBeacon Firmware: 1 – 0x68B0 [x 10 milliseconds]

Default Parameter Value: NonBeacon Firmware: 0

Related Commands: SM (Sleep Mode), ST (Time before Sleep), DP (Disassociation Cyclic Sleep Period, BE (Beacon Order)

**ST (Time before Sleep) Command**

<Sleep Mode (Low Power)> The ST command is used to set and read the period of inactivity (no serial or RF data is sent or received) before activating Sleep Mode.

**NonBeacon Firmware**

Set/Read time period of inactivity (no serial or RF data is sent or received) before activating Sleep Mode. ST parameter is only valid with Cyclic Sleep settings (SM = 4 - 5).

Coordinator and End Device ST values must be equal.

AT Command: ATST

Parameter Range: NonBeacon Firmware: 1 – 0xFFFF [x 1 millisecond]

Default Parameter Value: NonBeacon Firmware: 0x1388 (5000 decimal)

Related Commands: SM (Sleep Mode), ST (Time before Sleep)

**VL (Firmware Version - Verbose)**

<Diagnostics> The VL command is used to read detailed version information about the RF module. The information includes: application build date; MAC, PHY and bootloader versions; and build dates.

AT Command: ATVL

Parameter Range: 0 – 0xFF [x 100 milliseconds]

Default Parameter Value: 0x28 (40 decimal)

### VR (Firmware Version) Command

---

<Diagnostics> The VR command is used to read which firmware version is stored in the module.

AT Command: ATVR

Parameter Range: 0 – 0xFFFF [read only]

---

XBee version numbers will have four significant digits. The reported number will show three or four numbers and is stated in hexadecimal notation. A version can be reported as "ABC" or "ABCD". Digits ABC are the main release number and D is the revision number from the main release. "D" is not required and if it is not present, a zero is assumed for D. "B" is a variant designator. The following variants exist:

- "0" - Non-Beacon Enabled 802.15.4 Code
- "1" - Beacon Enabled 802.15.4 Code

### WR (Write) Command

---

<(Special)> The WR command is used to write configurable parameters to the RF module's non-volatile memory. Parameter values remain in the module's memory until overwritten by subsequent use of the WR Command.

AT Command: ATWR

---

If changes are made without writing them to non-volatile memory, the module reverts back to previously saved parameters the next time the module is powered-on.

---

NOTE: Once the WR command is sent to the module, no additional characters should be sent until after the "OK/r" response is received.

---

### 3.4. API Operation

By default, XBee/XBee-PRO RF Modules act as a serial line replacement (Transparent Operation) - all UART data received through the DI pin is queued up for RF transmission. When the module receives an RF packet, the data is sent out the DO pin with no additional information.

Inherent to Transparent Operation are the following behaviors:

- If module parameter registers are to be set or queried, a special operation is required for transitioning the module into Command Mode [refer to p19].
- In point-to-multipoint systems, the application must send extra information so that the receiving module(s) can distinguish between data coming from different remotes.

As an alternative to the default Transparent Operation, API (Application Programming Interface) Operations are available. API operation requires that communication with the module be done through a structured interface (data is communicated in frames in a defined order). The API specifies how commands, command responses and module status messages are sent and received from the module using a UART Data Frame.

#### 3.4.1. API Frame Specifications

Two API modes are supported and both can be enabled using the AP (API Enable) command. Use the following AP parameter values to configure the module to operate in a particular mode:

- AP = 0 (default): Transparent Operation (UART Serial line replacement)  
API modes are disabled.
- AP = 1: API Operation
- AP = 2: API Operation (with escaped characters)

Any data received prior to the start delimiter is silently discarded. If the frame is not received correctly or if the checksum fails, the data is silently discarded.

##### API Operation (AP parameter = 1)

When this API mode is enabled (AP = 1), the UART data frame structure is defined as follows:

Figure 3-01. UART Data Frame Structure:



MSB = Most Significant Byte, LSB = Least Significant Byte

##### API Operation - with Escape Characters (AP parameter = 2)

When this API mode is enabled (AP = 2), the UART data frame structure is defined as follows:

Figure 3-02. UART Data Frame Structure - with escape control characters:

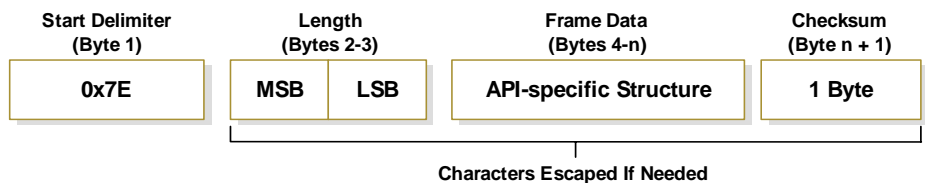

MSB = Most Significant Byte, LSB = Least Significant Byte

**Escape characters.** When sending or receiving a UART data frame, specific data values must be escaped (flagged) so they do not interfere with the UART or UART data frame operation. To escape an interfering data byte, insert 0x7D and follow it with the byte to be escaped XOR'd with 0x20.

**Data bytes that need to be escaped:**

- 0x7E – Frame Delimiter
- 0x7D – Escape
- 0x11 – XON
- 0x13 – XOFF

**Example** - Raw UART Data Frame (before escaping interfering bytes):  
 0x7E 0x00 0x02 0x23 0x11 0xCB  
 0x11 needs to be escaped which results in the following frame:  
 0x7E 0x00 0x02 0x23 0x7D 0x31 0xCB

Note: In the above example, the length of the raw data (excluding the checksum) is 0x0002 and the checksum of the non-escaped data (excluding frame delimiter and length) is calculated as:  
 $0xFF - (0x23 + 0x11) = (0xFF - 0x34) = 0xCB$ .

**Checksum**

To test data integrity, a checksum is calculated and verified on non-escaped data.

**To calculate:** Not including frame delimiters and length, add all bytes keeping only the lowest 8 bits of the result and subtract from 0xFF.

**To verify:** Add all bytes (include checksum, but not the delimiter and length). If the checksum is correct, the sum will equal 0xFF.

**3.4.2. API Types**

Frame data of the UART data frame forms an API-specific structure as follows:

Figure 3-03. UART Data Frame & API-specific Structure:

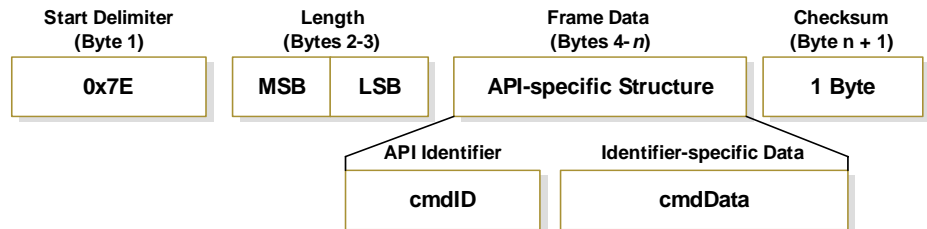

The cmdID frame (API-identifier) indicates which API messages will be contained in the cmdData frame (Identifier-specific data). Refer to the sections that follow for more information regarding the supported API types. Note that multi-byte values are sent big endian.

**Modem Status**

API Identifier: 0x8A

RF module status messages are sent from the module in response to specific conditions.

Figure 3-04. Modem Status Frames

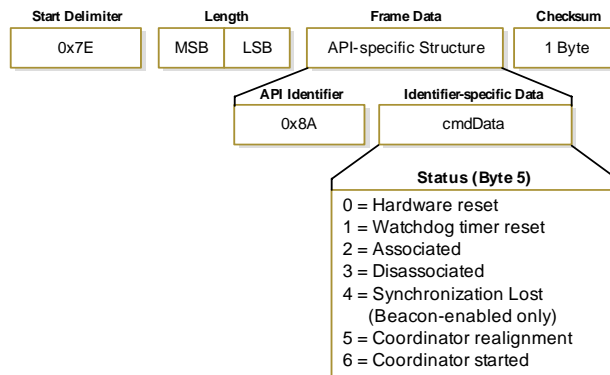

### AT Command

API Identifier Value: 0x08

The “AT Command” API type allows for module parameters to be queried or set. When using this command ID, new parameter values are applied immediately. This includes any register set with the “AT Command - Queue Parameter Value” (0x09) API type.

Figure 3-05. AT Command Frames

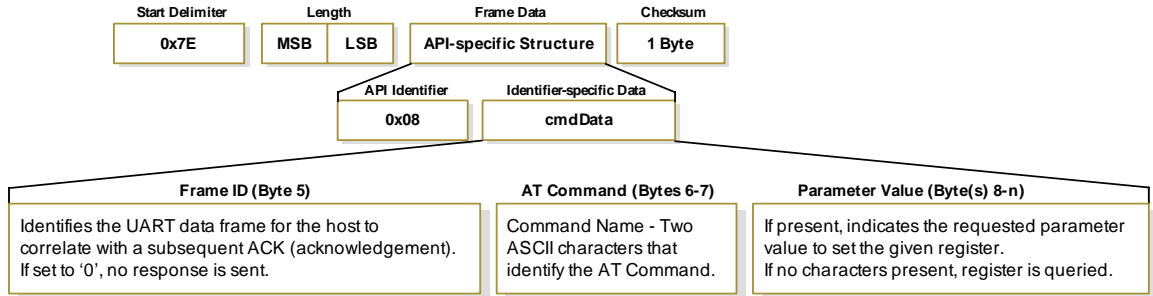
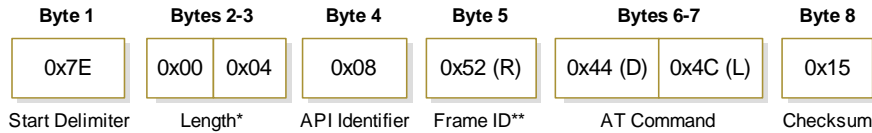

Figure 3-06. Example: API frames when reading the DL parameter value of the module.



\* Length [Bytes] = API Identifier + Frame ID + AT Command

\*\* “R” value was arbitrarily selected.

Figure 3-07. Example: API frames when modifying the DL parameter value of the module.

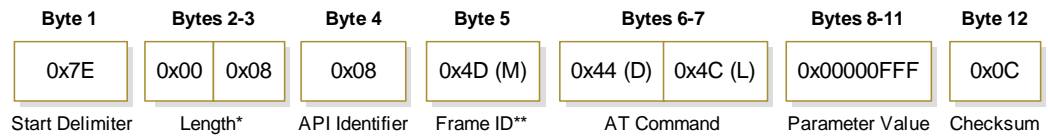

\* Length [Bytes] = API Identifier + Frame ID + AT Command + Parameter Value

\*\* “M” value was arbitrarily selected.

### AT Command - Queue Parameter Value

API Identifier Value: 0x09

This API type allows module parameters to be queried or set. In contrast to the “AT Command” API type, new parameter values are queued and not applied until either the “AT Command” (0x08) API type or the AC (Apply Changes) command is issued. Register queries (reading parameter values) are returned immediately.

Figure 3-08. AT Command Frames

(Note that frames are identical to the “AT Command” API type except for the API identifier.)

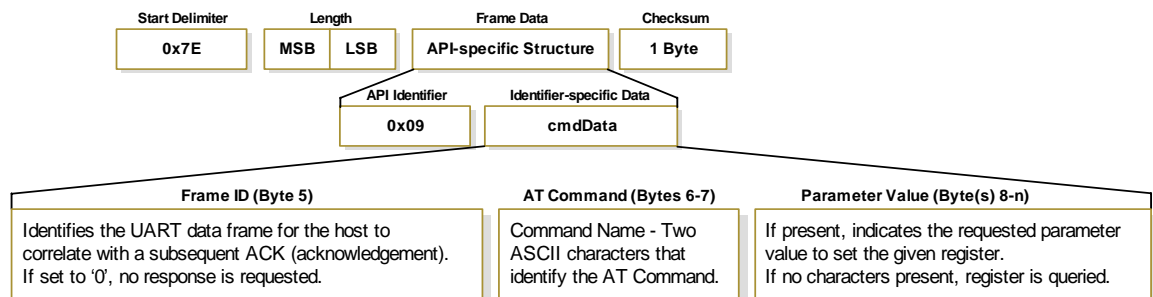

### AT Command Response

API Identifier Value: 0x88  
 Response to previous command.

In response to an AT Command message, the module will send an AT Command Response message. Some commands will send back multiple frames (for example, the ND (Node Discover) and AS (Active Scan) commands). These commands will end by sending a frame with a status of ATCMD\_OK and no cmdData.

Figure 3-09. AT Command Response Frames.

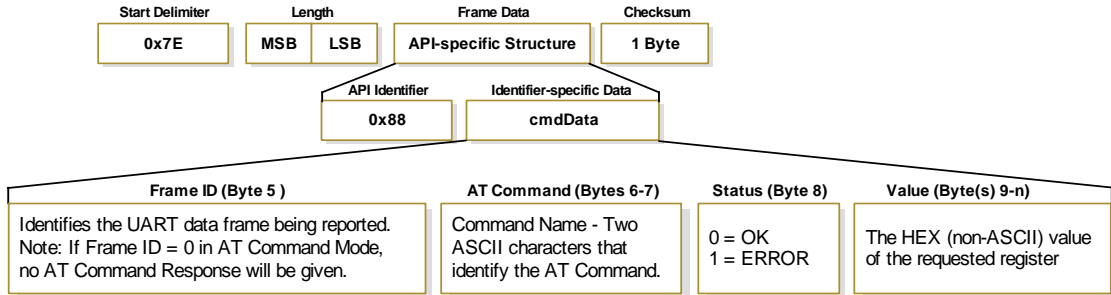

### TX (Transmit) Request: 64-bit address

API Identifier Value: 0x00  
 A TX Request message will cause the module to send RF Data as an RF Packet.

Figure 3-10. TX Packet (64-bit address) Frames

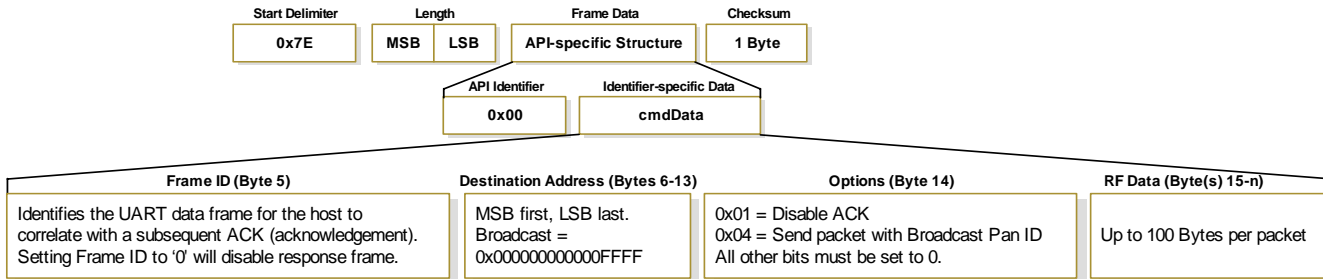

### TX (Transmit) Request: 16-bit address

API Identifier Value: 0x01  
 A TX Request message will cause the module to send RF Data as an RF Packet.

Figure 3-11. TX Packet (16-bit address) Frames

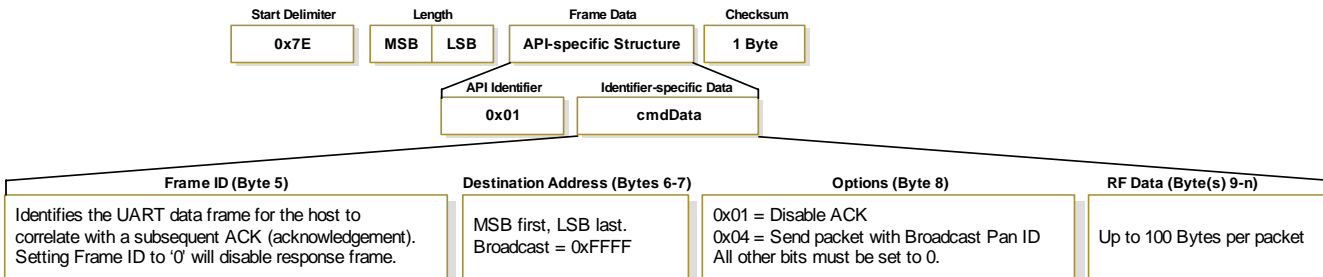

### TX (Transmit) Status

API Identifier Value: 0x89

When a TX Request is completed, the module sends a TX Status message. This message will indicate if the packet was transmitted successfully or if there was a failure.

Figure 3-12. TX Status Frames

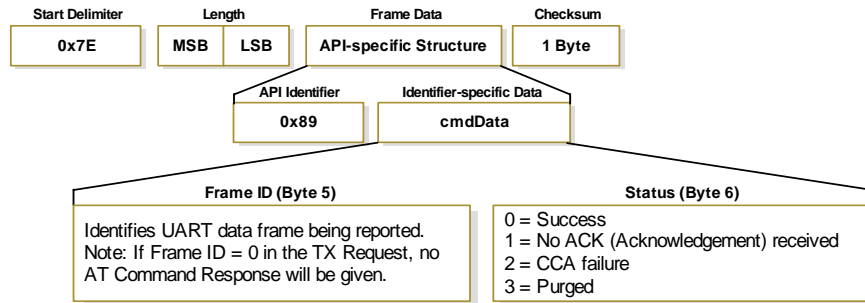

NOTES:

- "STATUS = 1" occurs when all retries are expired and no ACK is received.
- If transmitter broadcasts (destination address = 0x000000000000FFFF), only "STATUS = 0 or 2" will be returned.
- "STATUS = 3" occurs when Coordinator times out of an indirect transmission. Timeout is defined as (2.5 x SP (Cyclic Sleep Period) parameter value).

### RX (Receive) Packet: 64-bit Address

API Identifier Value: 0x80

When the module receives an RF packet, it is sent out the UART using this message type.

Figure 3-13. RX Packet (64-bit address) Frames

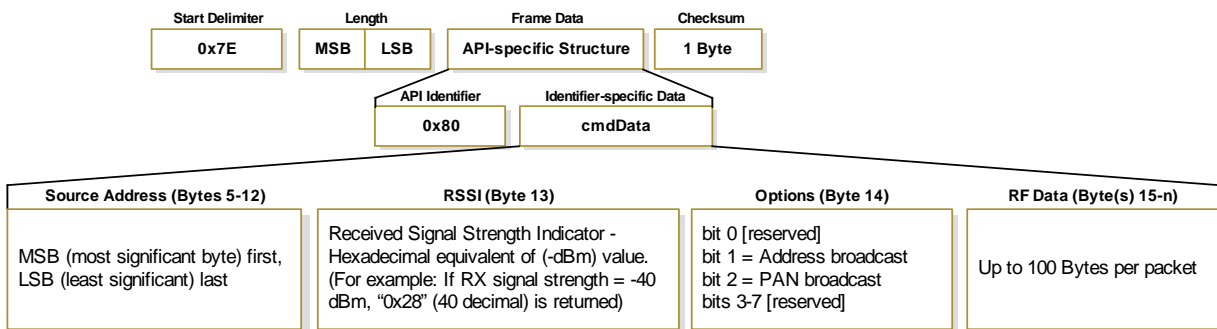

### RX (Receive) Packet: 16-bit Address

API Identifier Value: 0x81

When the module receives an RF packet, it is sent out the UART using this message type.

Figure 3-14. RX Packet (16-bit address) Frames

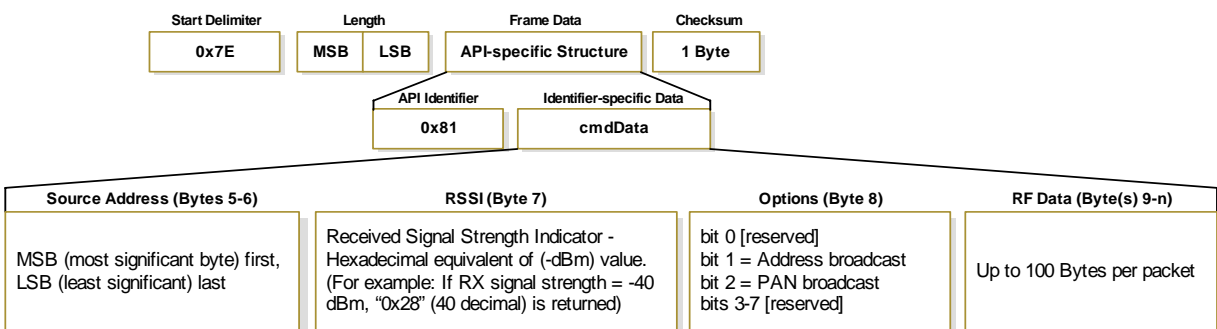

# Appendix A: Agency Certifications

## FCC Certification

XBee/XBee-PRO RF Modules comply with Part 15 of the FCC rules and regulations. Compliance with the labeling requirements, FCC notices and antenna usage guidelines is required.

To fulfill FCC Certification requirements, the OEM must comply with the following regulations:

1. The system integrator must ensure that the text on the external label provided with this device is placed on the outside of the final product [Figure A-01].
2. XBee/XBee-PRO RF Modules may only be used with antennas that have been tested and approved for use with this module.

## OEM Labeling Requirements



**WARNING:** The Original Equipment Manufacturer (OEM) must ensure that FCC labeling requirements are met. This includes a clearly visible label on the outside of the final product enclosure that displays the contents shown in the figure below.

**Figure A-01. Required FCC Label for OEM products containing the XBee/XBee-PRO RF Module**

Contains FCC ID: OUR-XBEE/OUR-XBEEPRO

The enclosed device complies with Part 15 of the FCC Rules. Operation is subject to the following two conditions: (i.) this device may not cause harmful interference and (ii.) this device must accept any interference received, including interference that may cause undesired operation.

\* The FCC ID for the XBee is "OUR-XBEE". The FCC ID for the XBee-PRO is "OUR-XBEEPRO".

## FCC Notices

**IMPORTANT:** The XBee/XBee-PRO OEM RF Module has been certified by the FCC for use with other products without any further certification (as per FCC section 2.1091). Modifications not expressly approved by MaxStream could void the user's authority to operate the equipment.

**IMPORTANT:** OEMs must test final product to comply with unintentional radiators (FCC section 15.107 & 15.109) before declaring compliance of their final product to Part 15 of the FCC Rules.

**IMPORTANT:** The RF module has been certified for remote and base radio applications. If the module will be used for portable applications, the device must undergo SAR testing.

This equipment has been tested and found to comply with the limits for a Class B digital device, pursuant to Part 15 of the FCC Rules. These limits are designed to provide reasonable protection against harmful interference in a residential installation. This equipment generates, uses and can radiate radio frequency energy and, if not installed and used in accordance with the instructions, may cause harmful interference to radio communications. However, there is no guarantee that interference will not occur in a particular installation.

If this equipment does cause harmful interference to radio or television reception, which can be determined by turning the equipment off and on, the user is encouraged to try to correct the interference by one or more of the following measures: Re-orient or relocate the receiving antenna, Increase the separation between the equipment and receiver, Connect equipment and receiver to outlets on different circuits, or Consult the dealer or an experienced radio/TV technician for help.

## FCC-approved Antennas

XBee/XBee-PRO RF Modules can be installed using antennas and cables constructed with standard connectors (Type-N, SMA, TNC, etc.) if the installation is performed professionally and according to FCC guidelines. For installations not performed by a professional, non-standard connectors (RPSMA, RPTNC, etc.) must be used.

The modules are FCC-approved for fixed base station and mobile applications on channels 0x0B - 0x1A (XBee) and 0x0C - 0x17 (XBee-PRO). If the antenna is mounted at least 20cm (8 in.) from nearby persons, the application is considered a mobile application. Antennas not listed in the table must be tested to comply with FCC Section 15.203 (Unique Antenna Connectors) and Section 15.247 (Emissions).

**XBee OEM RF Modules:** XBee Modules have been tested and approved for use with all of the antennas listed in the tables below (Cable-loss IS NOT required).

**XBee-PRO OEM RF Modules:** XBee-PRO Modules have been tested and approved for use with the antennas listed in the tables below (Cable-loss IS required when using antennas listed in Table A-02).

**Table A-01. Antennas approved for use with the XBee-PRO RF Modules (Cable-loss is not required)**

Part Number	Type (Description)	Gain	Application*	Min. Separation
A24-HSM-450	Dipole (Half-wave articulated RPSMA - 4.5")	2.1 dBi	Fixed/Mobile	20 cm
A24-HABSM	Dipole (Articulated RPSMA)	2.1 dBi	Fixed	20 cm
A24-HABUF-P5I	Dipole (Half-wave articulated bulkhead mount U.F.L. w/ 5" pigtail)	2.1 dBi	Fixed	20 cm
A24-QI	Monopole (Integrated whip - XBee 0x0B-0x18, XBee-PRO 0x0C-0x17)	1.5 dBi	Fixed	20 cm

**Table A-02. Antennas approved for use with the XBee-PRO RF Modules (Cable-loss is Required)**

Part Number	Type (Description)	Gain	Application*	Min. Separation	Required Cable-loss**
A24-C1	Surface Mount	-1.5 dBi	Fixed/Mobile	20 cm	-
A24-Y4NF	Yagi (4-element)	6.0 dBi	Fixed	2 m	8.1 dB
A24-Y6NF	Yagi (6-element)	8.8 dBi	Fixed	2 m	10.9 dB
A24-Y7NF	Yagi (7-element)	9.0 dBi	Fixed	2 m	11.1 dB
A24-Y9NF	Yagi (9-element)	10.0 dBi	Fixed	2 m	12.1 dB
A24-Y10NF	Yagi (10-element)	11.0 dBi	Fixed	2 m	13.1 dB
A24-Y12NF	Yagi (12-element)	12.0 dBi	Fixed	2 m	14.1 dB
A24-Y13NF	Yagi (13-element)	12.0 dBi	Fixed	2 m	14.1 dB
A24-Y15NF	Yagi (15-element)	12.5 dBi	Fixed	2 m	14.6 dB
A24-Y16NF	Yagi (16-element)	13.5 dBi	Fixed	2 m	15.6 dB
A24-Y16RM	Yagi (16-element, RPSMA connector)	13.5 dBi	Fixed	2 m	15.6 dB
A24-Y18NF	Yagi (18-element)	15.0 dBi	Fixed	2 m	17.1 dB
A24-F2NF	Omni-directional (Fiberglass base station)	2.1 dBi	Fixed/Mobile	20 cm	4.2 dB
A24-F3NF	Omni-directional (Fiberglass base station)	3.0 dBi	Fixed/Mobile	20 cm	5.1 dB
A24-F5NF	Omni-directional (Fiberglass base station)	5.0 dBi	Fixed/Mobile	20 cm	7.1 dB
A24-F8NF	Omni-directional (Fiberglass base station)	8.0 dBi	Fixed	2 m	10.1 dB
A24-F9NF	Omni-directional (Fiberglass base station)	9.5 dBi	Fixed	2 m	11.6 dB
A24-F10NF	Omni-directional (Fiberglass base station)	10.0 dBi	Fixed	2 m	12.1 dB
A24-F12NF	Omni-directional (Fiberglass base station)	12.0 dBi	Fixed	2 m	14.1 dB
A24-F15NF	Omni-directional (Fiberglass base station)	15.0 dBi	Fixed	2 m	17.1 dB
A24-W7NF	Omni-directional (Base station)	7.2 dBi	Fixed	2 m	9.3 dB
A24-M7NF	Omni-directional (Mag-mount base station)	7.2 dBi	Fixed	2 m	9.3 dB
A24-P8SF	Flat Panel	8.5 dBi	Fixed	2 m	8.6 dB
A24-P8NF	Flat Panel	8.5 dBi	Fixed	2 m	8.6 dB
A24-P13NF	Flat Panel	13.0 dBi	Fixed	2 m	13.1 dB
A24-P14NF	Flat Panel	14.0 dBi	Fixed	2 m	14.1 dB
A24-P15NF	Flat Panel	15.0 dBi	Fixed	2 m	15.1 dB
A24-P16NF	Flat Panel	16.0 dBi	Fixed	2 m	16.1 dB
A24-P19NF	Flat Panel	19.0 dBi	Fixed	2 m	19.1 dB

\* **If using the RF module in a portable application** (For example - If the module is used in a handheld device and the antenna is less than 20cm from the human body when the device is operation): The integrator is responsible for passing additional SAR (Specific Absorption Rate) testing based on FCC rules 2.1091 and FCC Guidelines for Human Exposure to Radio Frequency Electromagnetic Fields, OET Bulletin and Supplement C. The required SAR testing measures emissions from the module and how they affect the person. The testing results will be submitted to the FCC for approval prior to selling the integrated unit.

\*\* Required cable loss only applies to the higher power output XBee-PRO RF Modules and not to the XBee RF Modules.

**RF Exposure** (The following statement must be included as a CAUTION statement in OEM product manuals in order to alert users of FCC RF Exposure compliance)



**WARNING:** To satisfy FCC RF exposure requirements for mobile transmitting devices, a separation distance of 20 cm or more should be maintained between the antenna of this device and persons during device operation. To ensure compliance, operations at closer than this distance is not recommended. The antenna used for this transmitter must not be co-located in conjunction with any other antenna or transmitter.

## European Certification

The XBee/XBee-PRO RF Module has been certified for use in several European countries. For a complete list, refer to [www.maxstream.net](http://www.maxstream.net).

If the XBee/XBee-PRO RF Modules are incorporated into a product, the manufacturer must ensure compliance of the final product to the European harmonized EMC and low-voltage/safety standards. A Declaration of Conformity must be issued for each of these standards and kept on file as described in Annex II of the R&TTE Directive.

Furthermore, the manufacturer must maintain a copy of the XBee/XBee-PRO user manual documentation and ensure the final product does not exceed the specified power ratings, antenna specifications, and/or installation requirements as specified in the user manual. If any of these specifications are exceeded in the final product, a submission must be made to a notified body for compliance testing to all required standards.

## OEM Labeling Requirements

The 'CE' marking must be affixed to a visible location on the OEM product.

Figure A-02. CE Labeling Requirements



The CE mark shall consist of the initials "CE" taking the following form:

- If the CE marking is reduced or enlarged, the proportions given in the above graduated drawing must be respected.
- The CE marking must have a height of at least 5mm except where this is not possible on account of the nature of the apparatus.
- The CE marking must be affixed visibly, legibly, and indelibly.

## Restrictions

**Power Output:** The power output of the XBee-PRO RF Modules must not exceed 10 dBm. The power level is set using the PL command and the PL parameter must equal "0" (10 dBm).

**France:** France imposes restrictions on the 2.4 GHz band. Go to [www.art-telecom.fr](http://www.art-telecom.fr) or contact MaxStream for more information.

**Norway:** Norway prohibits operation near Ny-Alesund in Svalbard. More information can be found at the Norway Posts and Telecommunications site ([www.npt.no](http://www.npt.no)).

## Declarations of Conformity

MaxStream has issued Declarations of Conformity for the XBee/XBee-PRO RF Modules concerning emissions, EMC and safety. Files are located in the 'documentation' folder of the MaxStream CD.

### Important Note

MaxStream does not list the entire set of standards that must be met for each country. MaxStream customers assume full responsibility for learning and meeting the required guidelines for each country in their distribution market. For more information relating to European compliance of an OEM product incorporating the XBee/XBee-PRO RF Module, contact MaxStream, or refer to the following web sites:

CEPT ERC 70-03E - Technical Requirements, European restrictions and general requirements: Available at [www.ero.dk/](http://www.ero.dk/).

R&TTE Directive - Equipment requirements, placement on market: Available at [www.ero.dk/](http://www.ero.dk/).

## Antenna Usage (Europe)

---

When integrating high-gain antennas, European regulations stipulate EIRP power maximums. Use the following guidelines to determine which antennas to design into an application.

### XBee OEM RF Module

---

The following antenna types have been tested and approved for use with the XBee Module:

#### Antenna Type: Yagi

RF module was tested and approved with 15 dBi antenna gain with 1 dB cable-loss (EIRP Maximum of 14 dBm). Any Yagi type antenna with 14 dBi gain or less can be used with no cable-loss.

#### Antenna Type: Omni-directional

RF module was tested and approved with 15 dBi antenna gain with 1 dB cable-loss (EIRP Maximum of 14 dBm). Any Omni-directional type antenna with 14 dBi gain or less can be used with no cable-loss.

#### Antenna Type: Flat Panel

RF module was tested and approved with 19 dBi antenna gain with 4.8 dB cable-loss (EIRP Maximum of 14.2 dBm). Any Flat Panel type antenna with 14.2 dBi gain or less can be used with no cable-loss.

### XBee-PRO OEM RF Module (@ 10 dBm Transmit Power, PL parameter value must equal 0)

---

The following antennas have been tested and approved for use with the XBee-PRO Module:

- Chip (-1.5 dBi)
- Dipole (2.1 dBi, Omni-directional, Articulated RPSMA, MaxStream part number A24-HABSM)
- Attached Monopole Whip (1.5 dBi)

The XBee-PRO Module was not tested for use with high-gain antennas.

## IC (Industry Canada) Certification

---

### Labeling Requirements

---

Labeling requirements for Industry Canada are similar to those of the FCC. A clearly visible label on the outside of the final product enclosure must display one of the following texts:

**Contains Model XBee Radio, IC: 4214A-XBEE**

**Contains Model XBee-PRO Radio, IC: 4214A-XBEEPRO**

The integrator is responsible for its product to comply with IC ICES-003 & FCC Part 15, Sub. B - Unintentional Radiators. ICES-003 is the same as FCC Part 15 Sub. B and Industry Canada accepts FCC test report or CISPR 22 test report for compliance with ICES-003.

# Appendix B: Development Guide

## Development Kit Contents

The XBee Professional Development Kit includes the hardware and software needed to rapidly create long range wireless data links between devices. XBee and XBee-PRO Starter Kits are also available. The Starter Kits contain fewer modules and accessories.

**Table B-01. Items Included in the Development Kit**

Item	Qty.	Description	Part #
XBee-PRO Module	2	(1) OEM RF Module w/ U.FL antenna connector (1) OEM RF Module w/ attached wire antenna	XBP24-AUI-001 XBP24-AWI-001
XBee Module	3	(1) OEM RF Module w/ U.FL antenna connector (1) OEM RF Module w/ attached whip antenna (1) OEM RF Module w/ chip antenna	XB24-AUI-001 XB24-AWI-001 XB24-ACI-001
RS-232 Development Board	4	Board for interfacing between modules and RS-232 devices (Converts signal levels, displays diagnostic info, & more)	XBIB-R
USB Development Board	1	Board for interfacing between modules & USB devices (Converts signal levels, displays diagnostic info, & more)	XBIB-U
RS-232 Cable (6', straight-through)	1	Cable for connecting RS-232 interface board with DTE devices (devices that have a male serial DB-9 port - such as most PCs)	JD2D3-CDS-6F
USB Cable (6')	1	Cable for connecting USB interface board to USB devices	JU1U2-CSB-6F
Serial Loopback Adapter	1	[Red] Adapter for configuring the module assembly (module + RS-232 interface board) to function as a repeater for range testing	JD2D3-CDL-A
NULL Modem Adapter (male-to-male)	1	[Black] Adapter for connecting the module assembly (module + RS-232 interface board) to other DCE (female DB-9) devices	JD2D2-CDN-A
NULL Modem Adapter (female-to-female)	1	[Gray] Adapter for connecting serial devices. It allows users to bypass the radios to verify serial cabling is functioning properly.	JD3D3-CDN-A
Power Adapter (9VDC, 1 A)	1	Adapter for powering the RS-232 development board	JP5P2-9V11-6F
Battery Clip (9V)	1	Clip for remotely powering the RS-232 board w/ a 9V battery	JP2P3-C2C-4I
RPSMA Antenna	2	RPSMA half-wave dipole antenna (2.4 GHz, 2.1 dB)	A24-HASM-450
RF Cable Assembly	2	Adapter for connecting RPSMA antenna to U.FL connector	JF1R6-CR3-4I
CD	1	Documentation and Software	MD0030
Quick Start Guide	1	Step-by-step instruction on how to create wireless links & test range capabilities of the modules	MD0026

## Interfacing Options

The development kit includes an RS-232 and a USB interface board. Both boards provide a direct connection to many serial devices and therefore provide access to the RF module registries. Parameters stored in the registry allow OEMs and integrators to customize the modules to suite the needs of their data radio systems.

The following sections illustrate how to use the interface boards for development purposes. The MaxStream Interface board provides means for connecting the module to any node that has an available RS-232 or USB connector. Since the module requires signals to enter at TTL voltages, one of the main functions of the interface board is to convert signals between TTL levels and RS-232 and USB levels.

**Note:** In the following sections, an OEM RF Module mounted to an interface board will be referred to as a "Module Assembly".

## RS-232 Development Board

### External Interface

#### B-01a. Reset Switch

The Reset Switch is used to reset (re-boot) the RF module. This switch only applies when using the configuration tabs of MaxStream's X-CTU Software.

#### B-01b. I/O & Power LEDs

LEDs indicate RF module activity as follows:

- Yellow (top LED) = Serial Data Out (to host)
- Green (middle) = Serial Data In (from host)
- Red (bottom) = Power/Association Indicator (Refer to the D5 (DIO5 Configuration) parameter)



#### B-01c. Serial Port

Standard female DB-9 (RS-232) connector.

#### B-01d. RSSI LEDs

RSSI LEDs indicate the amount of fade margin present in an active wireless link. Fade margin is defined as the difference between the incoming signal strength and the module's receiver sensitivity.

- 3 LEDs ON = Very Strong Signal (> 30 dB fade margin)
- 2 LEDs ON = Strong Signal (> 20 dB fade margin)
- 1 LED ON = Moderate Signal (> 10 dB fade margin)
- 0 LED ON = Weak Signal (< 10 dB fade margin)

#### B-01e. Power Connector

5-14 VDC power connector

#### B-02a. DIP Switch

DIP Switch functions are not supported in this release. Future downloadable firmware versions will support DIP Switch configurations.

Figure B-01. Front View

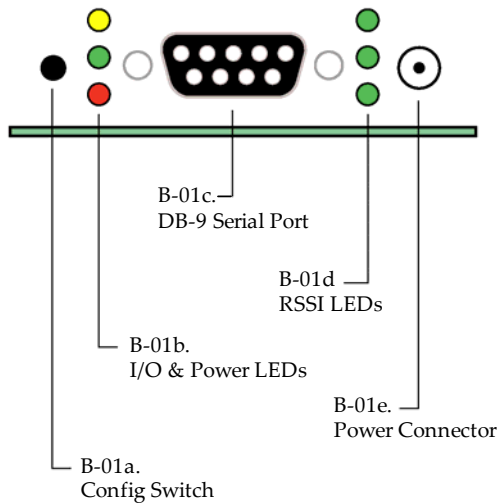
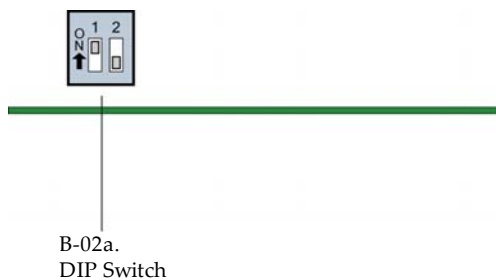

Figure B-02. Back View



## RS-232 Pin Signals

Figure B-03. Pins used on the female RS-232 (DB-9) Serial Connector

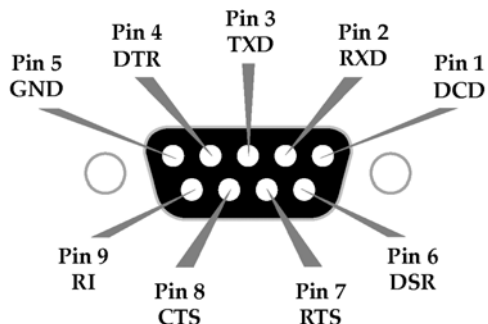

Table B-02. Pin Assignments and Implementations

DB-9 Pin	RS-232 Name	Description	Implementation*
1	DCD	Data-Carrier-Detect	Connected to DSR (pin6)
2	RXD	Receive Data	Serial data exiting the module assembly (to host)
3	TXD	Transmit Data	Serial data entering into the module assembly (from host)
4	DTR	Data-Terminal-Ready	Can enable Power-Down on the module assembly
5	GND	Ground Signal	Ground
6	DSR	Data-Set-Ready	Connected to DCD (pin1)
7	$\overline{\text{RTS}}$ / CMD	Request-to-Send / Command Mode	Provides $\overline{\text{RTS}}$ flow control or enables Command Mode
8	$\overline{\text{CTS}}$	Clear-to-Send	Provides $\overline{\text{CTS}}$ flow control
9	RI	Ring Indicator	Optional power input that is connected internally to the positive lead of the front power connector

\* Functions listed in the implementation column may not be available at the time of release.

## Wiring Diagrams

Figure B-04. DTE Device (RS-232, male DB-9 connector) wired to a DCE Module Assembly (female DB-9)

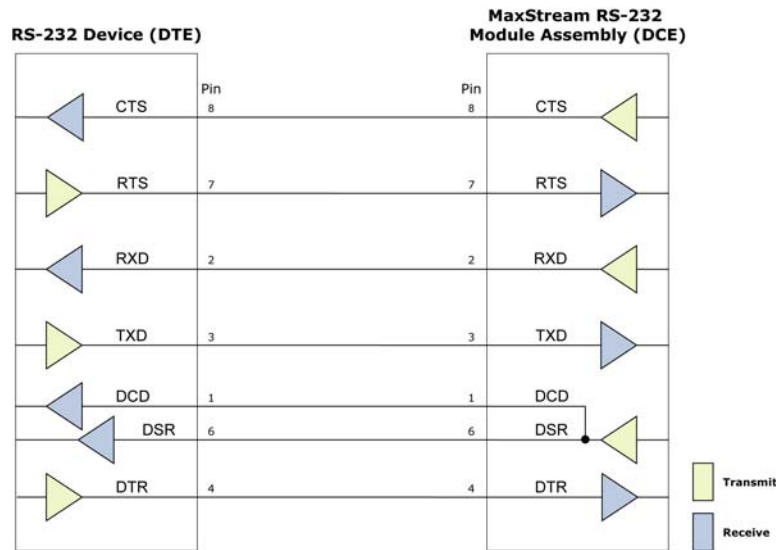
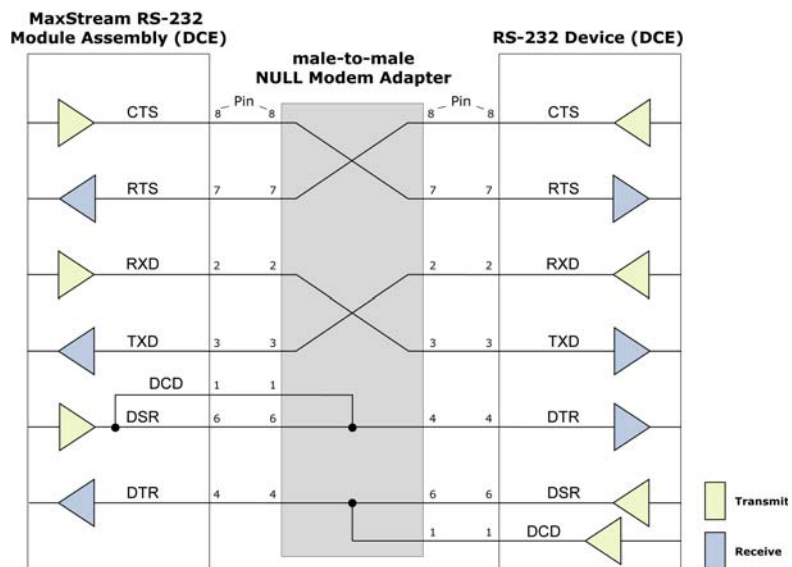
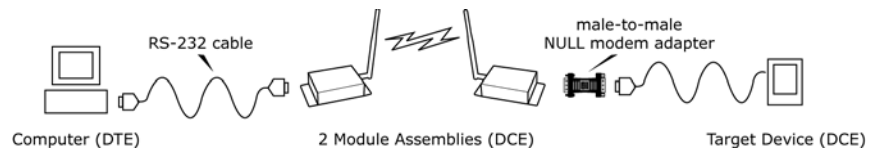

Figure B-05. DCE Module Assembly (female DB-9 connector) wired to a DCE Device (RS-232, male DB-9)



### Sample Wireless Connection: DTE <-> DCE <-> DCE <-> DCE

Figure B-06. Typical wireless link between DTE and DCE devices



## Adapters

The development kit includes several adapters that support the following functions:

- Performing Range Tests
- Testing Cables
- Connecting to other RS-232 DCE and DTE devices
- Connecting to terminal blocks or RJ-45 (for RS-485/422 devices)

### NULL Modem Adapter (male-to-male)

**Part Number: JD2D2-CDN-A (Black, DB-9 M-M)** The male-to-male NULL modem adapter is used to connect two DCE devices. A DCE device connects with a straight-through cable to the male serial port of a computer (DTE).

Figure B-07. Male NULL modem adapter and pinouts

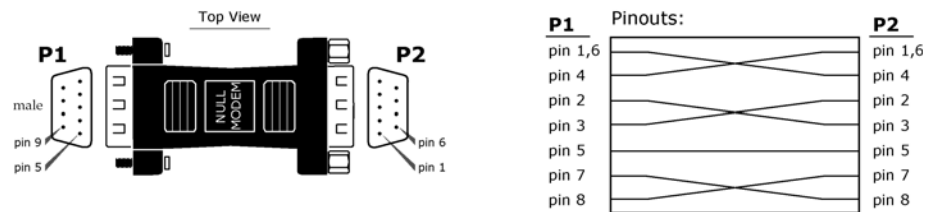
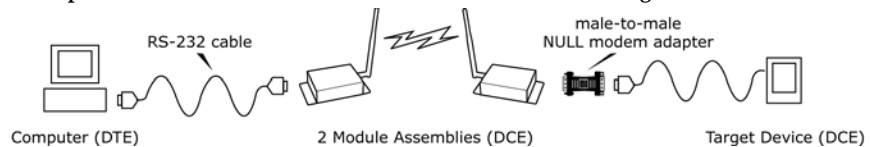

Figure B-08. Example of a MaxStream Radio Modem (DCE Device) connecting to another DCE device



### NULL Modem Adapter (female-to-female)

**Part Number: JD3D3-CDN-A (Gray, DB-9 F-F)** The female-to-female NULL modem adapter is used to verify serial cabling is functioning properly. To test cables, insert the female-to-female NULL modem adapter in place of a pair of module assemblies (RS-232 interface board + XTend Module) and test the connection without the modules in the connection.

Figure B-09. Female NULL modem adapter and pinouts

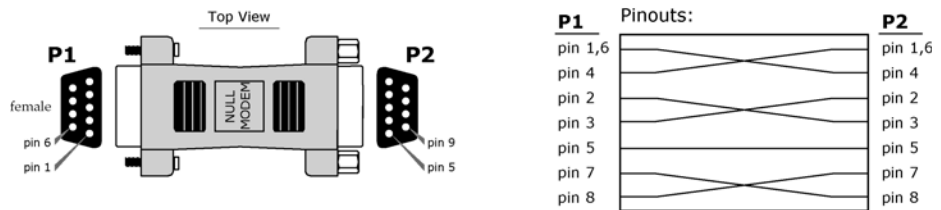

### Serial Loopback Adapter

**Part Number: JD2D3-CDL-A (Red, DB-9 M-F)** The serial loopback adapter is used for range testing. During a range test, the serial loopback adapter configures the module to function as a repeater by looping serial data back into the radio for retransmission.

Figure B-10. Serial loopback adapter and pinouts

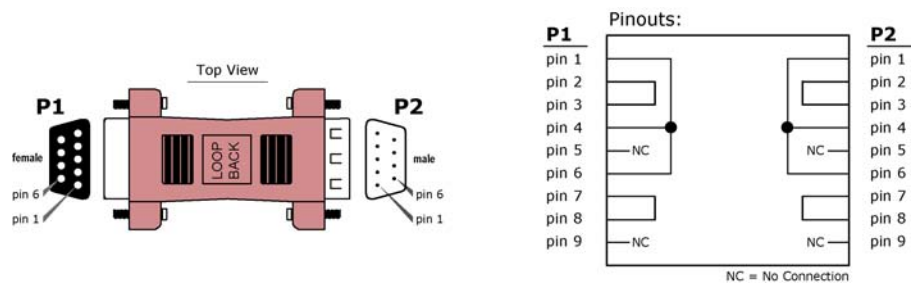

## USB Development Board

### External Interface

#### B-11a. I/O & Power LEDs

Figure B-11. Front View

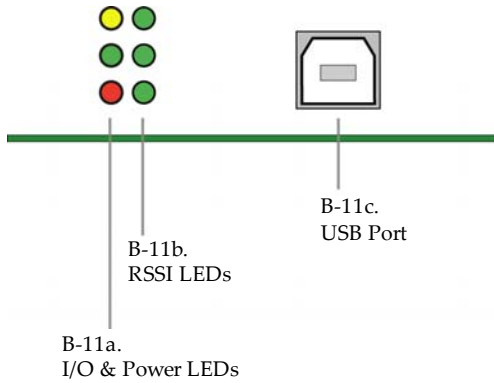

LEDs indicate RF module activity as follows:

- Yellow (top LED) = Serial Data Out (to host)
- Green (middle) = Serial Data In (from host)
- Red (bottom) = Power/Association Indicator (Refer to the D5 (DIO5 Configuration) parameter)



#### B-11b. RSSI LEDs

RSSI LEDs indicate the amount of fade margin present in an active wireless link. Fade margin is defined as the difference between the incoming signal strength and the module's receiver sensitivity.

- 3 LEDs ON = Very Strong Signal (> 30 dB fade margin)
- 2 LEDs ON = Strong Signal (> 20 dB fade margin)
- 1 LED ON = Moderate Signal (> 10 dB fade margin)
- 0 LED ON = Weak Signal (< 10 dB fade margin)

#### B-11c. USB Port

Standard Type-B OEM connector is used to communicate with OEM host and power the RF module.

#### B-12a. DIP Switch

DIP Switch functions are not supported in this release. Future downloadable firmware versions will support the DIP Switch configurations.

#### B-12b. Reset Switch

The Reset Switch is used to reset (re-boot) the RF module.

Figure B-12. Back View

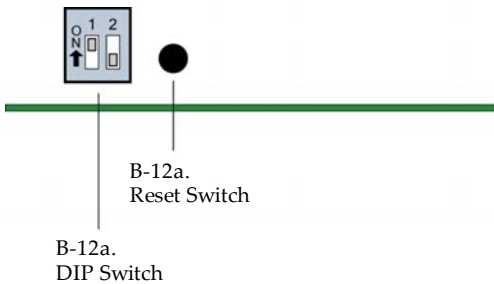

### USB Pin Signals

Table B-03. USB signals and their implantations on the XBee/XBee-PRO RF Module

Pin	Name	Description	Implementation
1	VBUS	Power	Power the RF module
2	D-	Transmitted & Received Data	Transmit data to and from the RF module
3	D+	Transmitted & Received Data	Transmit data to and from the RF module
4	GND	Ground Signal	Ground

## X-CTU Software

X-CTU is a MaxStream-provided software program used to interface with and configure Max-Stream RF Modules. The software application is organized into the following four tabs:

- PC Settings tab - Setup PC serial ports for interfacing with an RF module
- Range Test tab - Test the RF module's range and monitor packets sent and received
- Terminal tab - Set and read RF module parameters using AT Commands
- Modem Configuration tab - Set and read RF module parameters

Figure B-13. X-CTU User Interface (PC Settings, Range Test, Terminal and Modem Configuration tabs)

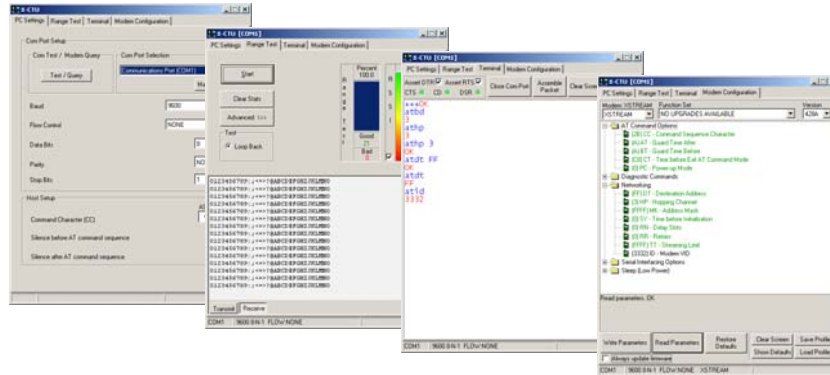

NOTE: PC Setting values are visible at the bottom of the Range Test, Terminal and Modem Configuration tabs. A shortcut for editing PC Setting values is available by clicking on any of the values.

## Install

Double-click the "setup\_X-CTU.exe" file and follow prompts of the installation screens. This file is located in the 'software' folder of the MaxStream CD and also under the 'Downloads' section of the following web page: [www.maxstream.net/support/downloads.php](http://www.maxstream.net/support/downloads.php)

### Setup

To use the X-CTU software, a module assembly (An RF module mounted to an interface Board) must be connected to a serial port of a PC. The interface data rate and parity settings of the serial port ("PC Settings" tab) must match those of the module (BD (Baud Rate) and NB (Parity) parameters).

## Serial Communications Software

A terminal program is built into the X-CTU Software. Other terminal programs such as "HyperTerminal" can also be used. When issuing AT Commands through a terminal program interface, use the following syntax:

Figure B-14. Syntax for sending AT Commands

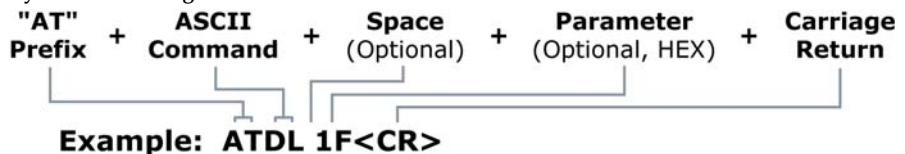

NOTE: To read a parameter value stored in a register, leave the parameter field blank.

The example above issues the DL (Destination Address Low) command to change destination address of the module to "0x1F". To save the new value to the module's non-volatile memory, issue WR (Write) command after modifying parameters.

# Appendix C: Additional Information

## 1-Year Warranty

XBee/XBee-PRO RF Modules from MaxStream, Inc. (the "Product") are warranted against defects in materials and workmanship under normal use, for a period of 1-year from the date of purchase. In the event of a product failure due to materials or workmanship, MaxStream will repair or replace the defective product. For warranty service, return the defective product to MaxStream, shipping prepaid, for prompt repair or replacement.

The foregoing sets forth the full extent of MaxStream's warranties regarding the Product. Repair or replacement at MaxStream's option is the exclusive remedy. THIS WARRANTY IS GIVEN IN LIEU OF ALL OTHER WARRANTIES, EXPRESS OR IMPLIED, AND MAXSTREAM SPECIFICALLY DISCLAIMS ALL WARRANTIES OF MERCHANTABILITY OR FITNESS FOR A PARTICULAR PURPOSE. IN NO EVENT SHALL MAXSTREAM, ITS SUPPLIERS OR LICENSORS BE LIABLE FOR DAMAGES IN EXCESS OF THE PURCHASE PRICE OF THE PRODUCT, FOR ANY LOSS OF USE, LOSS OF TIME, INCONVENIENCE, COMMERCIAL LOSS, LOST PROFITS OR SAVINGS, OR OTHER INCIDENTAL, SPECIAL OR CONSEQUENTIAL DAMAGES ARISING OUT OF THE USE OR INABILITY TO USE THE PRODUCT, TO THE FULL EXTENT SUCH MAY BE DISCLAIMED BY LAW. SOME STATES DO NOT ALLOW THE EXCLUSION OR LIMITATION OF INCIDENTAL OR CONSEQUENTIAL DAMAGES. THEREFORE, THE FOREGOING EXCLUSIONS MAY NOT APPLY IN ALL CASES. This warranty provides specific legal rights. Other rights which vary from state to state may also apply.

## Ordering Information

Figure C-01. Divisions of the XBee/XBee-PRO RF Module Part Numbers

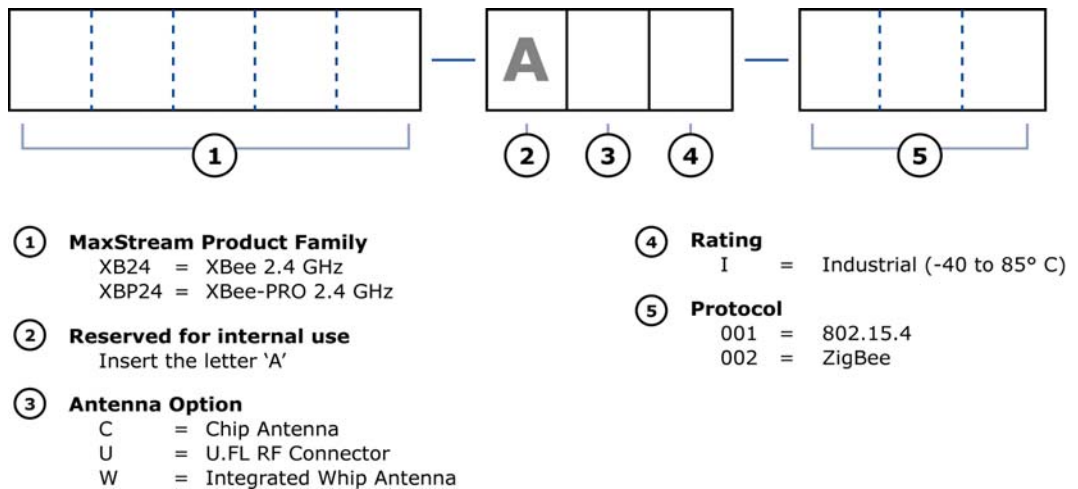

For example:

XBP24-AWI-001 = XBee-PRO OEM RF Module, 2.4 GHz, integrated whip antenna, Industrial temperature rating, IEEE 802.15.4 standard

